

Dell™ XPS™ 720

Owner's Manual

Model DCDO

Notes, Notices, and Cautions



NOTE: A NOTE indicates important information that helps you make better use of your computer.



NOTICE: A NOTICE indicates either potential damage to hardware or loss of data and tells you how to avoid the problem.



CAUTION: A CAUTION indicates a potential for property damage, personal injury, or death.

If you purchased a Dell™ n Series computer, any references in this document to Microsoft® Windows® operating systems are not applicable.

Information in this document is subject to change without notice.

© 2007 Dell Inc. All rights reserved.

Reproduction in any manner whatsoever without the written permission of Dell Inc. is strictly forbidden.

Trademarks used in this text: *Dell*, the *DELL* logo, *XPS*, *H2C*, *Inspiron*, *Dell Precision*, *Dimension*, *OptiPlex*, *Latitude*, *PowerEdge*, *PowerVault*, *PowerApp*, *TravelLite*, *Strike Zone*, and *Dell OpenManage* are trademarks of Dell Inc.; *Intel*, *Pentium*, *Celeron*, and *Intel Core 2 Extreme* are either trademarks or registered trademarks of Intel Corporation; *Microsoft*, *Windows*, *Windows Vista*, and the *Windows Vista* Start button are either trademarks or registered trademarks of Microsoft Corporation in the United States and/or other countries. *Bluetooth* is a registered trademark owned by Bluetooth SIG, Inc. and is used by Dell under license.

Other trademarks and trade names may be used in this document to refer to either the entities claiming the marks and names or their products. Dell Inc. disclaims any proprietary interest in trademarks and trade names other than its own.

Model DCDO

April 2007

P/N KP688

Rev. A00

Contents

Finding Information	9
1 Setting Up and Using Your Computer	13
Front and Back View of the Computer	13
Front View	13
Front I/O Connectors	15
Back View	16
Back I/O Connectors	17
Attaching the Computer Stand	18
Installing Your Computer in an Enclosure	20
Connecting Monitors	22
Connecting a Monitor (Without an Adapter)	23
Connecting a Monitor (With an Adapter)	24
Connecting a Monitor in a Dual Graphics Card Configuration	25
Connecting Two or More Monitors	27
Connecting a TV	27
Changing the Display Settings to Support Two or More Monitors	28
About Your RAID Configuration	29
RAID Level 0 Configuration	29
RAID Level 1 Configuration	30
RAID Level 0+1 Configuration	30
RAID Level 5 Configuration	32
Configuring Your Hard Drives for RAID	32
Setting Your Computer to RAID-Enabled Mode	33
Using the NVIDIA MediaShield ROM Utility	33
Using NVIDIA MediaShield	34
Using Multimedia	37
Copying CD, DVD, and Blu-ray Disc™ (BD) Media	38
Helpful Tips	40
Using a Media Card Reader (Optional)	41
Network Setup Wizard	42

Transferring Information to a New Computer	43
Power Management Options in Windows XP	44
Standby Mode	44
Hibernate Mode	45
Power Options Properties	45
Power Management Options in Windows Vista	47
Sleep Mode	47
Hibernate Mode	47
Configuring Power Management Settings	47
2 Optimizing for Greater Performance	49
Understanding Dual-Graphics Technology	49
Understanding CPU Overclocking	49
3 Dell™ QuickSet	51
4 Troubleshooting	53
Solving Problems	53
Battery Problems	53
Drive Problems	53
E-Mail, Modem, and Internet Problems	55
Error Messages	56
IEEE 1394 Device Problems	57
Keyboard Problems	57
Lockups and Software Problems	58
Memory Problems	59
Mouse Problems	60
Network Problems	60
Power Problems	61
Printer Problems	61
Scanner Problems	62
Sound and Speaker Problems	63
Video and Monitor Problems	63
Power Lights	65

Diagnostic Lights	66
Beep Codes	69
System Messages	70
Dell Diagnostics	72
When to Use Dell Diagnostics	72
Starting Dell Diagnostics From Your Hard Drive	72
Starting Dell Diagnostics From the Drivers and Utilities Media	73
Dell Diagnostics Main Menu	74
Drivers	75
What Is a Driver?	75
Identifying Drivers	75
Reinstalling Drivers and Utilities	76
Using Windows Device Driver Rollback	76
Using the Drivers and Utilities Media	76
Restoring Your Operating System	78
Using Microsoft Windows System Restore	78
Using Dell PC Restore and Dell Factory Image Restore	79
Using the Operating System Media	82
Troubleshooting Software and Hardware Problems	83
5 Removing and Installing Parts	85
Before You Begin	85
Recommended Tools	85
Preparing to Work Inside Your Computer	85
Removing the Computer Cover	86
Inside View of Your Computer	88
System Board Components	89
Memory	90
DDR2 Memory Overview	90
Addressing Memory Configurations	91
Installing Memory	92
Removing Memory	93

Cards	94
Removing PCI and PCI Express Cards	95
Installing PCI and PCI Express Cards.	97
Removing a PCI Express Graphics Card from a Dual Configuration	100
Installing a PCI Express Graphics Card in a Dual Configuration	102
Network Adapter and Sound Card Settings	105
Drives	106
About Serial ATA Drives	107
General Drive Installation Guidelines.	107
Hard Drive	108
Removing a Hard Drive	108
Installing a Hard Drive	110
Drive Panel	113
Removing the Drive Panel	113
Replacing the Drive Panel	114
Floppy Drive	115
Removing a Floppy Drive	115
Installing a Floppy Drive	117
Media Card Reader	119
Removing a Media Card Reader	119
Installing a Media Card Reader.	121
Optical Drive	123
Removing an Optical Drive	123
Installing an Optical Drive	125
Liquid Cooling Assembly	128
Safety Instructions for Liquid Cooling Assembly	128
Removing the Liquid Cooling Assembly	128
Installing the Liquid Cooling Assembly	131
Processor	132
Removing the Processor	132
Installing the Processor	133
Fans	135
Removing the Card Fan	135
Installing the Card Fan	137

Removing the Optional Hard Drive Fan	138
Installing the Optional Hard Drive Fan	139
System Board	140
Removing the System Board	140
Installing the System Board.	141
Power Supply	142
Power Supply (PSU) DC Connector Pin Assignments	143
Removing the Power Supply	152
Installing the Power Supply.	155
Front I/O Panel	156
Front I/O-Panel Components	156
Removing the Front I/O Panel.	157
Installing the I/O Panel	158
Battery	158
Replacing the Battery.	158
Removing the Computer Stand.	159
Replacing the Computer Cover	160
6 Appendix	163
Specifications	163
System Setup	168
Overview	168
Entering System Setup	168
System Setup Options.	169
Boot Sequence	175
Clearing Forgotten Passwords.	176
Clearing CMOS Settings	177
Cleaning Your Computer	178
Computer, Keyboard, and Monitor	178
Mouse.	178
Floppy Drive.	179
CDs and DVDs.	179

FCC Notices (U.S. Only)	179
Class A	180
Class B	180
FCC Identification Information	180
Contacting Dell.	181
Glossary	205
Index	215

Finding Information

 **NOTE:** Some features or media may be optional and may not ship with your computer. Some features or media may not be available in certain countries.

 **NOTE:** Additional information may ship with your computer.

What Are You Looking For?

- A diagnostic program for my computer
- Drivers for my computer
- My device documentation
- Desktop System Software (DSS)

Find It Here

Drivers and Utilities Media

Documentation and drivers are already installed on your computer. You can use the *Drivers and Utilities* media to reinstall drivers (see "Reinstalling Drivers and Utilities" on page 76), access your documentation or run the Dell Diagnostics (see "Dell Diagnostics" on page 72).



Readme files may also be included on your media to provide last-minute updates about technical changes to your computer or advanced technical reference material for technicians and experienced users.

NOTE: Drivers and documentation updates can be found at support.dell.com.

-
- Warranty information
 - Terms and Conditions (U.S. only)
 - Safety instructions
 - Regulatory information
 - Ergonomics information
 - End User License Agreement

Dell™ Product Information Guide

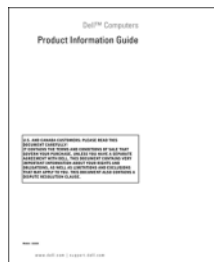

What Are You Looking For?

- How to set up my computer

Find It Here

Setup Diagram

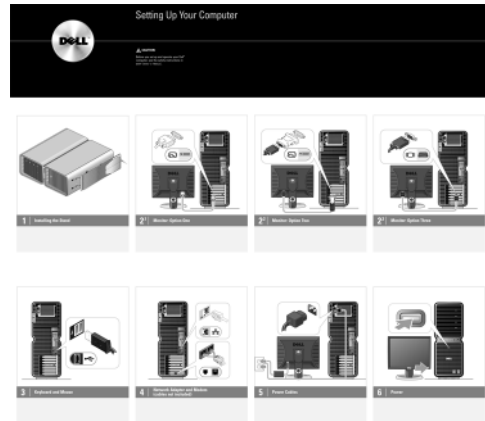

-
- Service Tag and Express Service Code
 - Microsoft® Windows® Product Key Label

Service Tag and Microsoft Windows Product Key

These labels are located on your computer.

- Use the Service Tag to identify your computer when you use support.dell.com or contact support.
- Enter the Express Service Code to direct your call when contacting support.



What Are You Looking For?

- Solutions — Troubleshooting hints and tips, articles from technicians, online courses, and frequently asked questions
- Community — Online discussion with other Dell customers
- Upgrades — Upgrade information for components, such as the memory, hard drive, and operating system
- Customer Care — Contact information, service call and order status, and warranty and repair information
- Service and Support — Service call status, support history, service contract, and online discussions with support
- Reference — Computer documentation, details on my computer configuration, product specifications, and white papers
- Downloads — Certified drivers, patches, and software updates
- Desktop System Software (DSS) — If you reinstall the operating system on your computer, you should also reinstall the DSS utility. DSS automatically detects your computer and operating system and installs the updates appropriate for your configuration, providing critical updates for your operating system and support for Dell™ 3.5-inch USB floppy drives, Intel® Pentium® M processors, optical drives, and USB devices. DSS is necessary for correct operation of your Dell computer.

-
- How to use your Windows™ operating system
 - How to work with programs and files
 - How to personalize my desktop

Find It Here

Dell Support Website — support.dell.com

NOTE: Select your region or business segment to view the appropriate support site.

To download Desktop System Software:

- 1** Go to support.dell.com, select your business segment, and then enter your Service Tag or product model.
- 2** Select **Drivers & Downloads**, and then click **Go**.
- 3** Select your operating system and language, and then search for the keyword *Desktop System Software*.

NOTE: The support.dell.com user interface may vary depending on your selections.

Windows Help and Support

- 1** To access Windows Help and Support:
 - In Windows XP, click **Start** and click **Help and Support**.
 - In Windows Vista™, click the Windows Vista Start button  and click **Help and Support**.
- 2** Type a word or phrase that describes your problem, and then click the arrow icon.
- 3** Click the topic that describes your problem.
- 4** Follow the instructions on the screen.

What Are You Looking For?

- How to reinstall my operating system

Find It Here**Operating System Media**

The operating system is already installed on your computer. To reinstall your operating system, use the *Operating System* media.



After you reinstall the operating system, use the *Drivers and Utilities* media to reinstall drivers for the devices that came with your computer.

The operating system product key label is located on your computer.



NOTE: The color of your *Operating System* media varies according to the operating system you ordered.

Setting Up and Using Your Computer

Front and Back View of the Computer

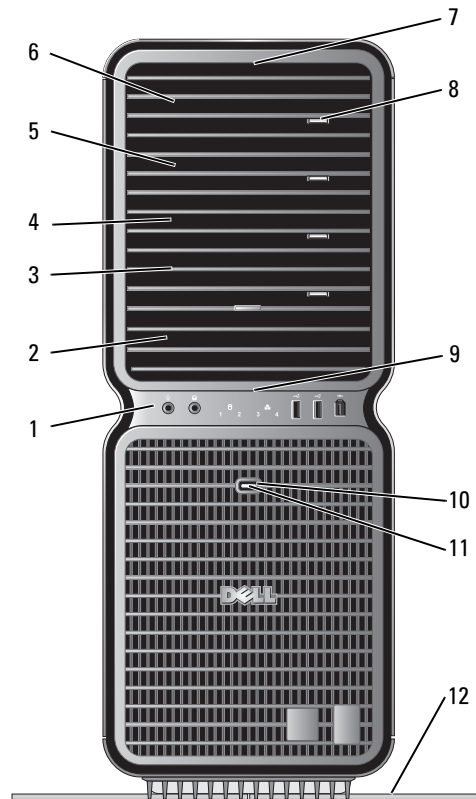
Front View



1	front I/O connectors	Plug USB and other devices into the appropriate connectors (see "Front I/O Connectors" on page 15).
2	3.5-inch drive bays (2)	Can hold an optional Media Card Reader or floppy drive.
3-6	5.25-inch drive bays (4)	Can hold an optical or SATA hard drive in a 5.25-inch drive bay carrier. NOTE: The hard drive carrier is only for use in the 5.25-inch drive bays. The floppy-drive/Media Card Reader and hard drive carriers are not interchangeable.
7	front panel LEDs (4)	Use the sequence of these diagnostics lights to help troubleshoot a problem with your computer (see "Dell Diagnostics" on page 72). NOTE: The color of the front panel LEDs can be adjusted in system setup (see "System Setup" on page 168).
8	optical drive tray eject button (4)	Use to eject the drive tray of an optical drive. NOTE: The optical drive tray eject button is not a handle. The self-tending doors open automatically when the eject button is pressed and the drive tray is ejected.
9	front panel LEDs (4)	Multi-colored lights provide illumination for the front of the computer. NOTE: The color of the front panel LEDs can be adjusted in system setup (see "System Setup" on page 168).
10	power button	Press to turn on the computer.  NOTICE: To avoid losing data, do not use the power button to turn off the computer. Instead, perform an operating system shutdown. NOTE: The power button can also be used to wake the system or to place it into a power-saving state (see "Power Management Options in Windows XP" on page 44).
11	power light	The power light illuminates and blinks or remains solid to indicate different states: <ul style="list-style-type: none"> • No light — The computer is turned off. • Steady green — The computer is in a normal operating state. • Blinking green — The computer is in a power-saving state. • Steady amber — There may be a problem with an installed device. • Blinking amber — An internal power problem may exist.
12	computer stand	Attach the computer stand to provide stability to the system.  CAUTION: The computer stand should be installed at all times to ensure maximum system stability. Failure to install the stand could result in the computer tipping over, potentially resulting in bodily injury or damage to the computer.

Front I/O Connectors

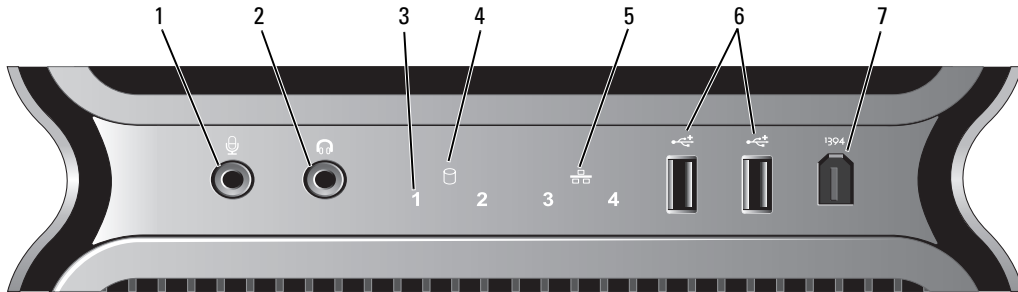

1	microphone connector	Use the microphone connector to attach a personal computer microphone for voice or musical input into a sound or telephony program.
2	headphone connector	Use the headphone connector to attach headphones.
3	diagnostic lights (4)	Use the sequence of these diagnostics lights to help troubleshoot a problem with your computer (see "Dell Diagnostics" on page 72).
4	hard-drive activity light	The hard drive light is on when the computer reads data from or writes data to the hard drive. The light may also be on when a device such as your CD player is operating.
5	network link light	The network link light is on when a good connection exists between a network and the computer.
6	USB 2.0 connectors (2)	Use the front USB connectors for devices that you connect occasionally, such as flash memory keys, cameras, or bootable USB devices. For more information on bootable USB devices see "Boot Sequence" on page 175. Dell recommends that you use the back USB connectors for devices that typically remain connected, such as printers and keyboards.
7	IEEE 1394 connector	Use the IEEE 1394 connector for high-speed data devices such as digital video cameras and external storage devices.

Back View

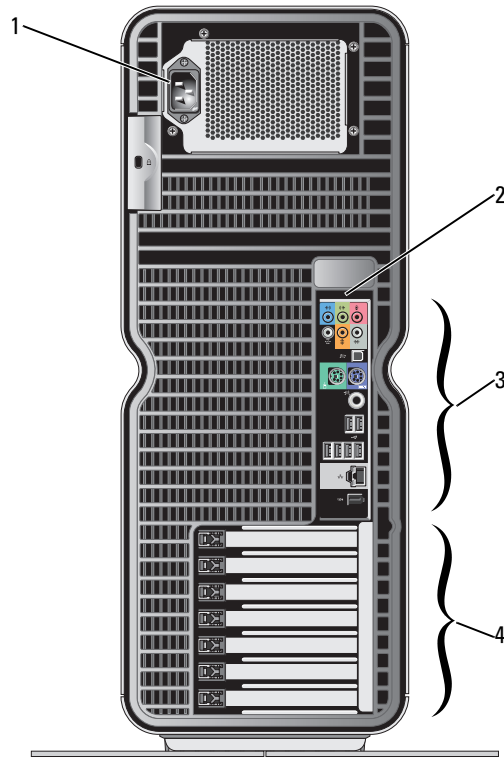

1	power connector	Insert the power cable. The appearance of this connector may differ from what is pictured.
2	back panel LEDs (2)	Multi-colored lights provide illumination for the I/O panel on the back of the computer. NOTE: The color of the back panel LEDs can be adjusted in system setup (see "System Setup" on page 168).
3	back I/O connectors	Plug USB and other devices into the appropriate connectors (see "Back I/O Connectors" on page 17).
4	card slots	Access connectors for any installed PCI or PCI Express cards. NOTE: Some connector slots support full-length cards.

Back I/O Connectors

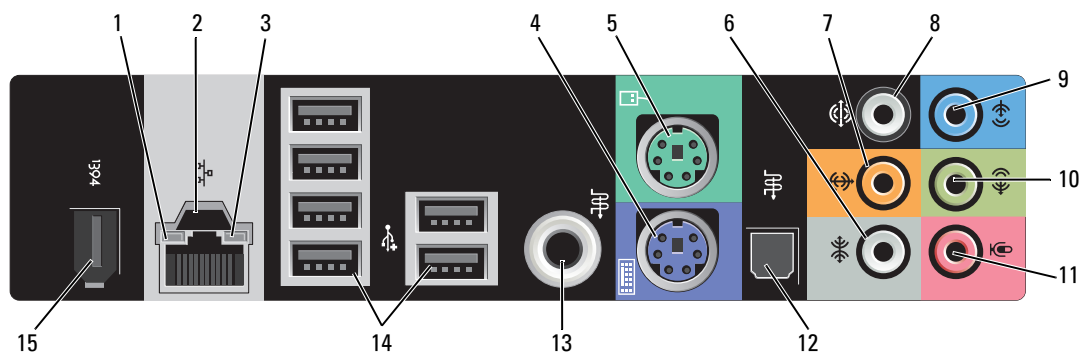

<p>1 link integrity light</p>	<ul style="list-style-type: none"> • Green — A good connection exists between a 10-Mbps network and the computer. • Orange — A good connection exists between a 100-Mbps network and the computer. • Yellow — A good connection exists between a 1000-Mbps (1-Gbps) network and the computer. • Off — The computer is not detecting a physical connection to the network.
<p>2 network adapter connector</p>	<p>⚠ NOTICE: Do not plug a telephone cable into the network adapter connector.</p> <p>Use the network adapter connector to attach your computer to a network or broadband device. Connect one end of a network cable to either a network jack or your network or broadband device, and then connect the other end of the network cable to the network adapter connector on your computer. A click indicates that the network cable has been securely attached.</p> <p>On computers with an additional network connector card, use the connectors on the card and on the back of the computer when setting up multiple network connections (such as a separate intra- and extranet).</p> <p>NOTE: Dell recommends that you use Category 5 wiring and connectors for your network. If you must use Category 3 wiring, force the network speed to 10 Mbps to ensure reliable operation.</p>
<p>3 network activity light</p>	<p>Flashes a yellow light when the computer is transmitting or receiving network data. A high volume of network traffic may make this light appear to be in a steady "on" state.</p>
<p>4 keyboard connector</p>	<p>Plug a standard PS/2 keyboard into the purple keyboard connector. Turn off the computer and any attached devices before you connect a keyboard to the computer. If you have a USB keyboard, plug it into a USB connector.</p>
<p>5 mouse connector</p>	<p>Plug a standard PS/2 mouse into the green mouse connector. Turn off the computer and any attached devices before you connect a mouse to the computer. If you have a USB mouse, plug it into a USB connector.</p>

6	side surround sound connector	Use the (silver) side surround connector to attach additional speakers.
7	center subwoofer/LFE connector	Use the (orange) subwoofer connector to attach a single subwoofer. NOTE: The LFE (Low Frequency Effects) Audio channel, found in digital surround sound audio schemes, carries only low frequency information of 80 Hz and below. The LFE channel drives a subwoofer to provide extremely low bass extension. Systems not using subwoofers can shunt the LFE information to the main speakers in the surround sound setup.
8	surround sound connector	Use the (black) surround sound connector to attach multichannel-capable speakers.
9	line-in connector	Use the (blue) line-in connector to attach a record/playback device such as a cassette player, CD player, or VCR. On computers with a sound card, use the connector on the card.
10	line-out/headphone connector	Use the (green) line-out connector to attach headphones and speakers with integrated amplifiers. On computers with a sound card, use the connector on the card.
11	microphone connector	Use the (pink) microphone connector to attach a personal computer microphone for voice or musical input into a sound or telephony program.
12	Optical S/PDIF connector	Use the optical S/PDIF connector to transmit digital audio without going through an analog audio conversion process.
13	RCA S/PDIF connector	Use the RCA S/PDIF connector to transmit digital audio without going through an analog audio conversion process.
14	USB 2.0 connectors (6)	Use the back USB connectors for devices that typically remain connected, such as printers and keyboards. NOTE: Dell recommends that you use the front USB connectors for devices that you connect occasionally, such as flash memory keys, cameras, or bootable USB devices.
15	IEEE 1394 connector	Use the IEEE 1394 connector for high-speed data devices such as digital video cameras and external storage devices.

Attaching the Computer Stand



CAUTION: Before you begin any of the procedures in this section, follow the safety instructions in the *Product Information Guide*.



CAUTION: Your computer is heavy and can be difficult to maneuver. Seek assistance before attempting to lift, move, or tilt the computer and always lift correctly to avoid injury; avoid bending over while lifting.

⚠ CAUTION: The computer stand should be installed at all times to ensure maximum system stability. Failure to install the stand could result in the computer tipping over, potentially resulting in bodily injury or damage to the computer.

- 1 Follow the procedures in "Before You Begin" on page 85.
- 2 Remove the thumb screw that is installed on the base of the computer.
✍ NOTE: If the thumb screw is not already installed in the stand, it has been packaged separately.
- 3 Insert the six alignment tabs into the corresponding slots on the base of the computer, then slide the stand forward until all six tabs catch in the slots.
- 4 Ensure that the screw hole on the stand is aligned with the screw hole on the base of the computer.
- 5 Insert the captive screw into the screw hole, then tighten the screw to secure the stand to the base of the computer.



- 1 captive screw 2 stabilizing feet (closed) 3 computer stand
4 slots (6)

- 6 With the help of an assistant, carefully set the computer upright.
- 7 Carefully, lift the rear of the computer and slide the stabilizing feet outward into the open position.

Installing Your Computer in an Enclosure

Installing your computer in an enclosure can restrict the airflow and impact your computer's performance, possibly causing it to overheat. Follow the guidelines below when installing your computer in an enclosure:

- ➔ **NOTICE:** The operating temperature specifications indicated in your Owner's Manual reflect the maximum ambient operating temperature. The room's ambient temperature needs to be a consideration when installing your computer in an enclosure. For example, if the ambient room temperature is at 25° C (77° F), depending on your computer's specifications, you only have 5° to 10° C (9° to 18° F) temperature margin before you reach your computer's maximum operating temperature. For details about your computer's specifications, see "Specifications" on page 163.
- Leave a 10.2 centimeter (4 inch) minimum clearance on all vented sides of the computer to permit the airflow required for proper ventilation.
- If your enclosure has doors, they need to be of a type that allows at least 30% airflow through the enclosure (front and back).

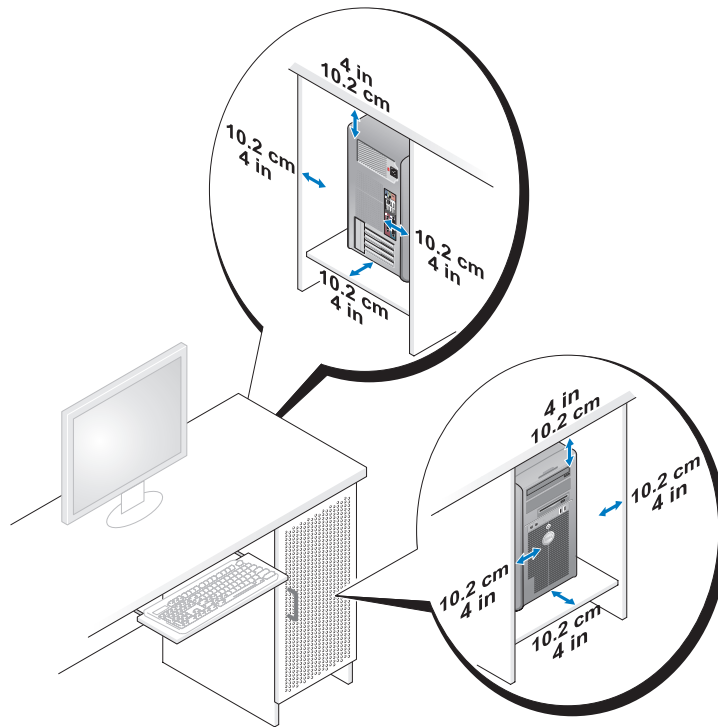

- If your computer is installed in a corner on a desk or under a desk, leave at least 5.1 centimeters (2 inch) of clearance from the back of the computer to the wall to permit the airflow required for proper ventilation.

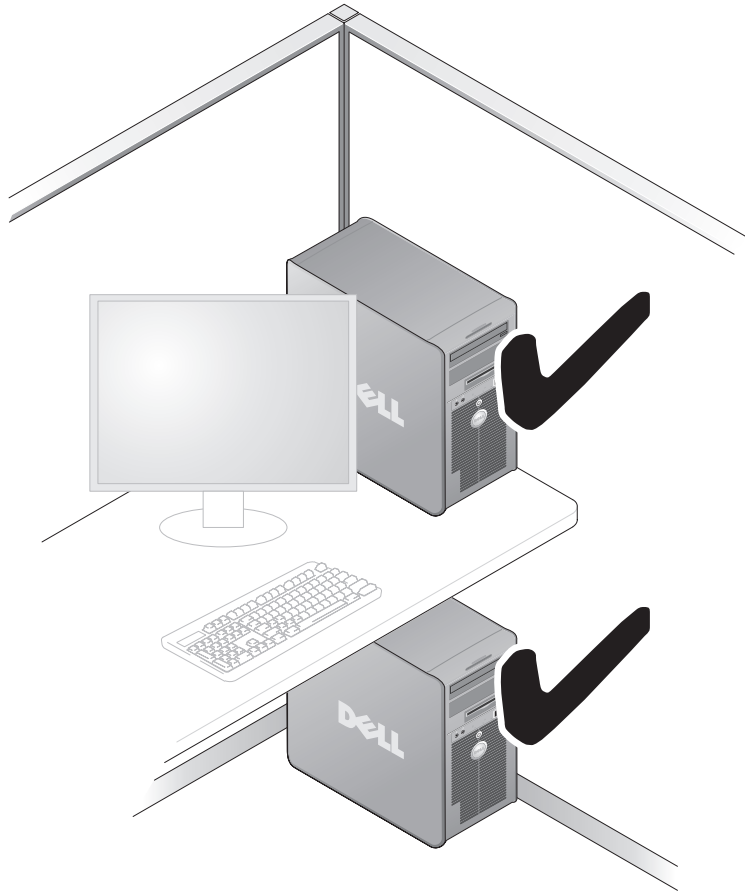

- Do not install your computer in an enclosure that does not allow airflow. Restricting the airflow impacts your computer's performance, possibly causing it to overheat.



Connecting Monitors



CAUTION: Before you perform any of the procedures in this section, follow the safety instructions in the *Product Information Guide*.



CAUTION: To reduce the risk of fire, electric shock, or injury, do not overload an electrical outlet, power strip, or convenience receptacle. The total ampere rating of all products plugged into an electrical outlet, power strip, or other receptacle should not exceed 80 percent of the branch circuit rating.



NOTE: Depending on the options selected when you purchased your computer, your video card may have two DVI ports, or one DVI and one VGA port.

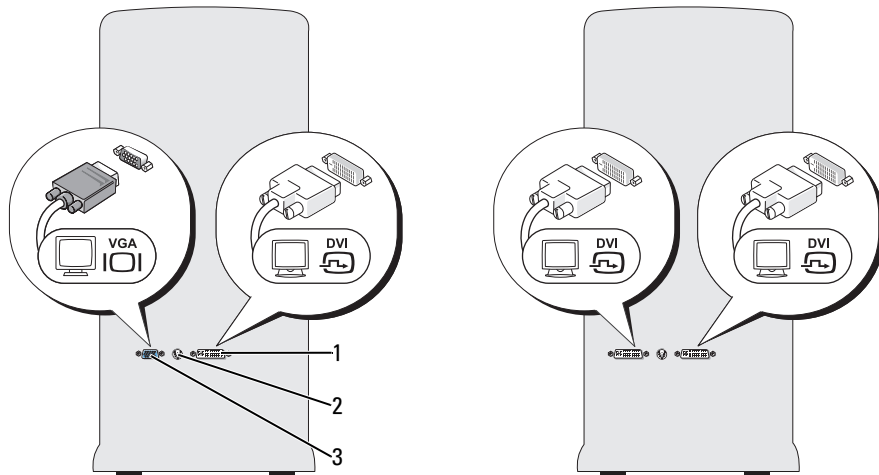

- 1 DVI (white) connector 2 TV-OUT connector 3 VGA (blue) connector

Connecting a Monitor (Without an Adapter)

CAUTION: Before you perform any of the procedures in this section, follow the safety instructions in the *Product Information Guide*.

NOTE: If your monitor has a VGA connector and your computer does not have a VGA port, follow the instructions in "Connecting a Monitor (With an Adapter)" on page 24.

- 1 Save and close all open files and exit all open programs.
- 2 Shut down the operating system:
 - In Windows XP, click **Start** → **Turn Off Computer** → **Turn off**.
 - In Windows Vista™, click the Windows Vista Start button , click the arrow in the lower-right corner of the Start menu as shown below, and then click **Shut Down**.



The computer turns off after the operating system shutdown process is complete.

- 3 Ensure that the computer and all attached devices are turned off. If your computer and attached devices did not automatically turn off when you shut down your operating system, press and hold the power button for about 4 seconds to turn them off. Disconnect the computer and all attached devices from their electrical outlets.

- 4 Connect the DVI or VGA connector of your monitor to the appropriate connector on the back of the computer:

To connect a monitor with a DVI connector, use the (white) DVI port on your computer.

To connect a monitor with a VGA connector, use the (blue) VGA port on your computer.

Connecting a Monitor (With an Adapter)

 **CAUTION:** Before you perform any of the procedures in this section, follow the safety instructions in the *Product Information Guide*.

 **NOTE:** In order to connect a monitor with a VGA connector to the DVI port on the back of your computer, a DVI-to-VGA adapter is required.

- 1 Save and close all open files and exit all open programs.
- 2 Shut down the operating system:
 - In Windows XP, click **Start**→**Turn Off Computer**→**Turn off**.
 - In Windows Vista, click **Start** , click the arrow in the lower-right corner of the Start menu as shown below, and then click **Shut Down**.



The computer turns off after the operating system shutdown process is complete.

- 3 Ensure that the computer and all attached devices are turned off. If your computer and attached devices did not automatically turn off when you shut down your operating system, press and hold the power button for about 4 seconds to turn them off.
- 4 Connect the DVI-to-VGA adapter to the VGA connector on your monitor, and then connect the other end of the adapter to the (white) DVI port on the back of the computer.

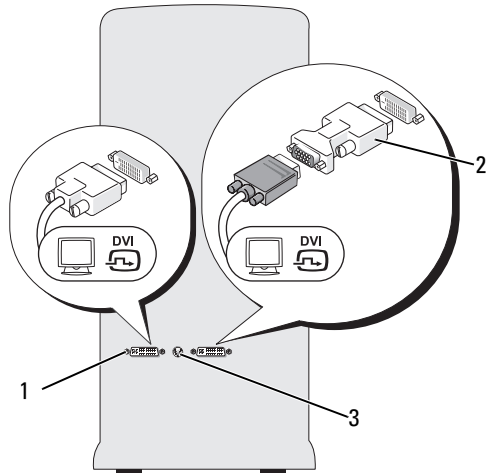

- 1 DVI (white) connector 2 DVI-to-VGA adapter (optional) 3 TV-OUT connector

Connecting a Monitor in a Dual Graphics Card Configuration

CAUTION: Before you perform any of the procedures in this section, follow the safety instructions in the *Product Information Guide*.

Dual graphics card configurations with multi-GPU technology enabled support only a single monitor. The monitor must be connected to the primary graphics card in order to function.

NOTE: If you have modified your primary graphics card settings in the BIOS, then the left DVI connector at the rear of your computer is the default primary connector.

NOTE: If your primary graphics card is equipped with two DVI ports and you are using a monitor with a VGA connector, a DVI-to-VGA adapter is required to connect the monitor. See "Connecting a Monitor (With an Adapter)" on page 24.

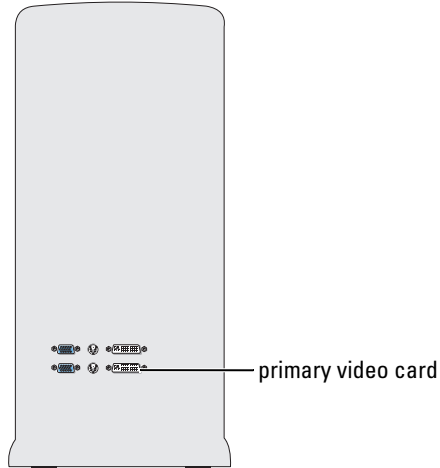

- 1 Save and close all open files and exit all open programs.
- 2 Shut down the operating system:
 - In Windows XP, click **Start**→**Turn Off Computer**→**Turn off**.
 - In Windows Vista, click **Start** , click the arrow in the lower-right corner of the Start menu as shown below, and then click **Shut Down**.



The computer turns off after the operating system shutdown process is complete.

- 3 Ensure that the computer and all attached devices are turned off. If your computer and attached devices did not automatically turn off when you shut down your operating system, press and hold the power button for about 4 seconds to turn them off.
- 4 Connect the DVI or VGA connector of your monitor to the appropriate connector on the computer's primary graphics card:

To connect a monitor with a DVI connector, use the (white) DVI port on the primary graphics card.

To connect a monitor with a VGA connector, use the (blue) VGA port on the primary graphics card.

Connecting Two or More Monitors

 **CAUTION:** Before you perform any of the procedures in this section, follow the safety instructions in the *Product Information Guide*.

 **NOTE:** In order to connect and use two or more monitors in a dual graphics card configuration, multi-GPU technology must be disabled. To disable multi-GPU, see "Changing the Display Settings to Support Two or More Monitors" on page 28.

 **NOTE:** Depending on the options selected when you purchased your computer, your video card may have two DVI ports, or one DVI and one VGA port.

- 1 Save and close all open files and exit all open programs.
- 2 Shut down the operating system:
 - In Windows XP, click **Start** → **Turn Off Computer** → **Turn off**.
 - In Windows Vista, click **Start** , click the arrow in the lower-right corner of the Start menu as shown below, and then click **Shut Down**.



The computer turns off after the operating system shutdown process is complete.

- 3 Ensure that the computer and all attached devices are turned off. If your computer and attached devices did not automatically turn off when you shut down your operating system, press and hold the power button for about 4 seconds to turn them off.

- 4 Connect two or more monitors to the appropriate DVI or VGA ports on the back of the computer.

 **NOTE:** In order to connect a monitor with a VGA connector to the DVI port on the back of your computer, a DVI-to-VGA adapter is required.

To connect two or more monitors directly to the DVI or VGA ports on your computer, see "Connecting a Monitor (Without an Adapter)" on page 23.

To connect the VGA connectors of one or more monitors to the DVI port(s) on your computer, see "Connecting a Monitor (With an Adapter)" on page 24.

- 5 Change the display settings to support multiple monitors (see "Changing the Display Settings to Support Two or More Monitors" on page 28).

Connecting a TV

 **CAUTION:** Before you perform any of the procedures in this section, follow the safety instructions in the *Product Information Guide*.

 **NOTE:** If you are connecting a TV to your computer, you may connect only one monitor (VGA or DVI) in addition to the TV.

 **NOTE:** See the documentation that came with your TV to ensure that you properly configure and connect the TV.

To connect a TV to your computer, an S-video cable is required. If you do not have an S-video cable, you may purchase one at most consumer electronics stores. An S-video cable is not included with your computer.

- 1 Save and close all open files and exit all open programs.
- 2 Shut down the operating system:
 - In Windows XP, click **Start**→**Turn Off Computer**→**Turn off**.
 - In Windows Vista, click **Start** , click the arrow in the lower-right corner of the Start menu as shown below, and then click **Shut Down**.



The computer turns off after the operating system shutdown process is complete.

- 3 Ensure that the computer and all attached devices are turned off. If your computer and attached devices did not automatically turn off when you shut down your operating system, press and hold the power button for about 4 seconds to turn them off.
- 4 Disconnect the computer and all attached devices from their electrical outlets.
- 5 Connect one end of the S-video cable to the TV-OUT connector on the back of the computer.
- 6 Connect the other end of the S-video cable to the S-video input connector on your TV.
- 7 Connect one monitor, as needed, with a DVI or VGA connector as described in "Connecting Monitors" on page 22.

Changing the Display Settings to Support Two or More Monitors

 **NOTE:** Dual graphics card configurations with multi-GPU technology enabled support only a single monitor. In order to connect and use two or more monitors in a dual graphics card configuration with multi-GPU technology, multi-GPU must be disabled.

- 1 With your monitors connected and turned on, turn on the computer.
The Microsoft® Windows® desktop displays on the primary monitor.
- 2 Disable multi-GPU technology in the display settings (applies only to dual graphics card configurations with multi-GPU technology enabled):
- 3 Enable clone mode or extended desktop mode in the display settings.
 - In clone mode, all monitors display the same image.
 - In extended desktop mode, you can drag objects from one screen to the other, increasing the amount of viewable work space.

For more information on changing the display settings for your graphics card, see the device's User's Guide in the Help and Support Center. (From the Help and Support Center, click **User and system guides**→**Device guides**, and then select the guide for your graphics card.)

About Your RAID Configuration

➡ NOTICE: In order to use the migrating option to convert a RAID configuration without losing data, your hard drive must initially be set up as a single drive RAID 0 array before the operating system is loaded onto the drive (see "Using the NVIDIA MediaShield ROM Utility" on page 33 for instructions).

This section provides an overview of the RAID configuration you may have selected when you purchased your computer. There are several RAID configurations available in the computer industry for different types of uses. Your computer supports RAID level 0, RAID level 1, RAID level 5 (customer-installed), or RAID level 0+1 (customer-installed). A RAID level 0 configuration is recommended for high-performance programs, while RAID level 1 is recommended for users that desire a high level of data integrity.

🔧 NOTE: RAID levels do not represent a hierarchy. A RAID level 1 configuration is not inherently better or worse than a RAID level 0 configuration.

The drives in a RAID configuration should be the same size in order to ensure that the larger drive does not contain unallocated (and therefore unusable) space.

RAID level 0 and RAID level 1 require a minimum of two drives. RAID level 5 requires a minimum of three drives. RAID level 0+1 requires a minimum of four drives.

RAID Level 0 Configuration

➡ NOTICE: Because a RAID level 0 configuration provides no data redundancy, a failure of one drive results in the loss of all data. To protect your data when using a RAID level 0 configuration, perform regular backups.

RAID level 0 uses a storage technique known as "data striping" to provide a high data access rate. Data striping is a method of writing consecutive segments, or stripes, of data sequentially across the physical drive(s) to create a large virtual drive. Data striping allows one of the drives to read data while the other drive is searching for and reading the next block.

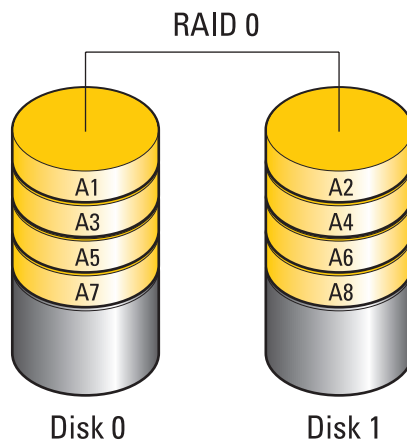

Another advantage of a RAID level 0 configuration is that it utilizes the full storage capacities of the drives. For example, two 120-GB hard drives combine to provide 240 GB of hard drive space on which to store data.

NOTE: In a RAID level 0 configuration, the size of the configuration is equal to the size of the smallest drive multiplied by the number of drives in the configuration.

RAID Level 1 Configuration

RAID level 1 uses a data-redundancy storage technique known as "mirroring" to enhance data integrity. When data is written to the primary drive, the data is also duplicated, or mirrored, on the second drive in the configuration. A RAID level 1 configuration sacrifices high data-access rates for its data redundancy advantages.

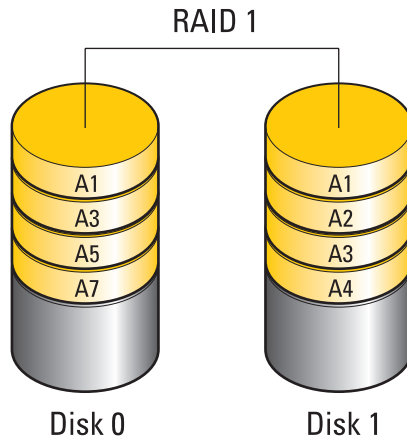

If a drive failure occurs, subsequent read and write operations are directed to the surviving drive. A replacement drive can then be rebuilt using the data from the surviving drive.

NOTE: In a RAID level 1 configuration, the size of the configuration is equal to the size of the smallest drive in the configuration.

RAID Level 0+1 Configuration

A RAID 0+1 array combines the high data access rate of a RAID level 0 array and the data protection (redundancy) of a RAID level 1 mirror by striping data across two drives and mirroring that striped data on a second set of two drives.

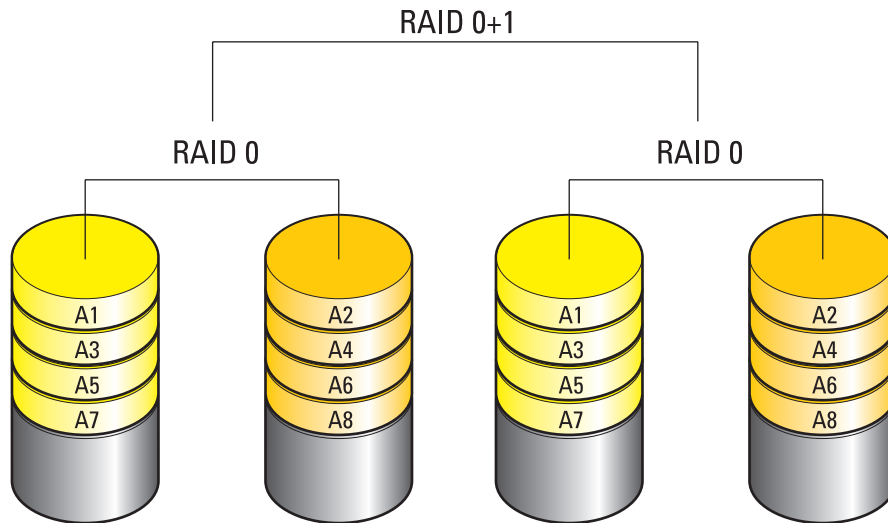

If a drive failure occurs, subsequent read and write operations are directed to the other surviving drives. A replacement drive can then be rebuilt using the data from the surviving drives. Also, because data is duplicated on the primary and additional drives, four 120-GB RAID level 1 drives collectively have a maximum of 240-GB on which to store data.

RAID Level 5 Configuration

RAID level 5 also uses data parity. RAID level 5 stripes both data and parity information across three or more drives. It provides data striping at the byte level and also stripe error correction information (rotating parity array). This results in excellent performance and good fault tolerance. RAID level 5 is one of the most popular implementations of RAID.

RAID level 5 is faster than RAID level 1, but requires more hard drives than a RAID level 0 or RAID level 1 configuration.

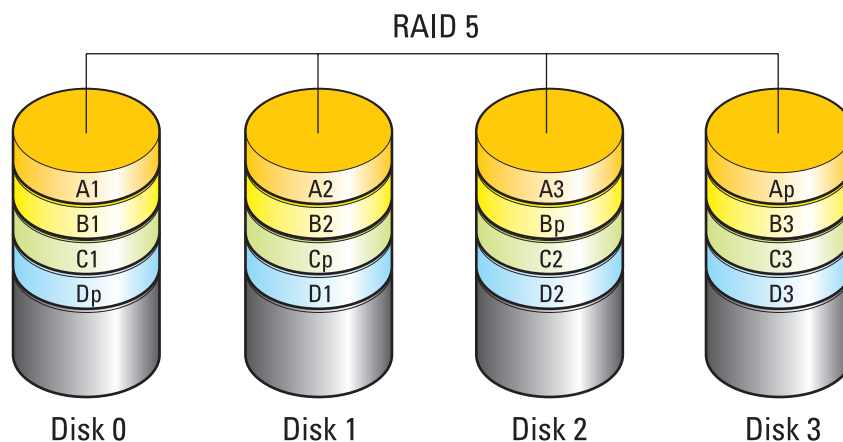

If a drive failure occurs, subsequent read and write operations are directed to the other surviving drives. A replacement drive can then be rebuilt using the data from the surviving drives. Also, because data is duplicated on the primary and additional drives, four 120-GB RAID level 1 drives collectively have a maximum of 360-GB on which to store data.

Configuring Your Hard Drives for RAID

Your computer can be configured for RAID, even if you did not select a RAID configuration when the computer was purchased. For an explanation of RAID levels and their requirements, see "About Your RAID Configuration" on page 29. For information on how to install a hard drive, see "Installing a Hard Drive" on page 110.



You can use one of two methods to configure RAID hard drive volumes. The first method uses the NVIDIA MediaShield ROM utility and is performed *before* you install the operating system onto the hard drive. The second method uses NVIDIA MediaShield and is performed *after* you have installed the operating system and NVIDIA RAID drivers.

Both methods require that you set your computer to RAID-enabled mode before you begin.

Setting Your Computer to RAID-Enabled Mode

- 1 Enter system setup (see "Entering System Setup" on page 168).
- 2 Press the up- and down-arrow keys to highlight **Drives**, then press <Enter>.
- 3 Press the up- and down-arrow keys to highlight the applicable SATA drive, then press <Enter>.
- 4 Press the left- and right-arrow keys to highlight **RAID On**, and then press <Enter>. Repeat the process, as needed, for each SATA hard drive.
 **NOTE:** For more information about RAID options, see "System Setup Options" on page 169.
- 5 Press <Esc>, press the left- and right-arrow keys to highlight **Save/Exit**, and then press <Enter> to exit system setup and resume the boot process.

Using the NVIDIA MediaShield ROM Utility

-  **NOTICE:** The following procedure will result in the loss of all data on your hard drive(s). Back up any data you want to keep before continuing.
-  **NOTE:** Do not use the following procedure to migrate an existing RAID configuration (see "Converting From One RAID Configuration to Another RAID Configuration" on page 35).

Hard drives of any size may be used to create a RAID configuration. Ideally, however, the drives should be of equal size to avoid unallocated or unused space. For an explanation of RAID levels and their requirements, see "About Your RAID Configuration" on page 29. For information on how to install a hard drive, see "Installing a Hard Drive" on page 110.

- 1 Enable RAID for each applicable hard drive on your computer (see "Setting Your Computer to RAID-Enabled Mode" on page 33).
- 2 Restart the computer.
- 3 Press <Ctrl><N> when prompted to enter the RAID BIOS.

 **NOTE:** If the operating system logo appears, continue to wait until you see the Microsoft Windows desktop, then shut down your computer and try again.

The **Define a New Array** window appears.

- 4 Press <Tab> to navigate to the **RAID Mode** field.
To create a RAID 0 configuration, use the arrow keys to select **Striping**.
To create a RAID 1 configuration, use the arrow keys to select **Mirroring**.
To create a RAID 0+1 configuration, use the arrow keys to select **Stripe Mirroring**.
To create a RAID 5 configuration, use the arrow keys to select **RAID 5**.
- 5 Press <Tab> to navigate to the **Free Disks** field.

- 6 Use the up- and down-arrow keys to select a hard drive to include in the RAID array and then use the right-arrow key to move the selected drive from the **Free Disks** field to the **Array Disks** field. Repeat for each disk you want to include in the RAID array.

 **NOTE:** Your computer supports a maximum of two drives per RAID 1 array and four drives per RAID 0 array.

- 7 After assigning the hard drives to an array, press <F9>.

The **Clear disk data** prompt appears.

-  **NOTICE:** You will lose all data on the selected drives in the next step.

- 8 Press <Y> to clear all data from the selected drives.

The **Array List** window appears.

- 9 To review the details of the array that you set up, use the arrow keys to highlight the array in the **Array Detail** window and press <Enter>.

The **Array Detail** window appears.

 **NOTE:** To delete an array, use the arrow keys to select the array and press <D>.

- 10 Press <Enter> to return to the previous screen.

- 11 Press <Ctrl><X> to exit the RAID BIOS.

Using NVIDIA MediaShield

NVIDIA MediaShield allows you to create, view, and manage RAID configurations.

-  **NOTE:** Use NVIDIA MediaShield to create a RAID configuration only when you are adding one or more new hard drives to an existing (non-RAID) single-drive computer, and you want to configure the new drive(s) into a RAID array.

Hard drives of any size may be used to create a RAID configuration using NVIDIA MediaShield. Ideally, however, the drives should be of equal size to avoid unallocated or unused space. For an explanation of RAID levels and their requirements, see "About Your RAID Configuration" on page 29.

Creating a RAID Array

-  **NOTICE:** The following procedure will result in the loss of all data on your hard drive(s). Back up any data you want to keep before continuing.

-  **NOTE:** Do not use the following procedure to migrate an existing RAID configuration (see "Converting From One RAID Configuration to Another RAID Configuration" on page 35).

- 1 Enable RAID on your hard drives (see "Setting Your Computer to RAID-Enabled Mode" on page 33).

- 2 After rebooting your computer, launch NVIDIA MediaShield.

- 3 Click **Create** under **System Tasks**.

The **NVIDIA Create Array Wizard** appears and lists the disks that are available for configuration.

- 4 Click **Next**.

- 5 Click **Custom**, then click **Next**.
- 6 Use the drop-down box to select **Striping (RAID 0)**, **Mirroring (RAID 1)**, **Stripe Mirroring (RAID 0+1)**, or **RAID 5**.
- 7 Click **Next**.

The **Free Disk Selection** window appears.

 **NOTE:** Only RAID-enabled hard drives are listed as free disks.

- 8 Click to select the drives that will make up the RAID configuration, click **Next**, and then click **Next** again.

 **NOTE:** Your computer supports a maximum of two drives per RAID 1 array and four per RAID 0 array.

The **Clearing System Data** window appears.

-  **NOTICE:** The **Clear System Data** option deletes all data on the selected drive.

- 9 Click **Next**.

- 10 Click **Finish** to create the RAID configuration.

The **MediaShield RAID management utility** window appears and lists the array along with any other installed hard drives.

Deleting a RAID Array

 **NOTE:** While this procedure deletes the RAID 1 volume, it also splits the RAID 1 volume into two non-RAID hard drives with a partition, and leaves any existing data files intact. Deleting a RAID 0 volume, however, destroys all data on the volume.

 **NOTE:** If your computer currently boots to RAID and you delete the RAID volume, your computer will become unbootable.

- 1 Launch **NVIDIA MediaShield**.
- 2 Click to select the array you want to delete.
- 3 Click **Delete Array** in the **System Tasks** pane.

The **NVIDIA Delete Array Wizard** appears.

- 4 Click **Next**.

A confirmation screen appears with the name and size of the array that you have marked for deletion.

- 5 Click **Finish** to delete the RAID configuration.

The **MediaShield RAID management utility** window appears and lists any remaining arrays along with any other installed hard drives.

Converting From One RAID Configuration to Another RAID Configuration

 **NOTICE:** In order to use the migrating option to convert a RAID configuration without losing data, your hard drive must initially be set up as a single drive RAID 0 array before the operating system is loaded onto the drive (see "Using the NVIDIA MediaShield ROM Utility" on page 33 for instructions).

NVIDIA MediaShield utilizes a one-step process known as migrating to change the current state of a disk or array without losing any data. If needed, additional hard drives can be added to an existing array, including a single-drive RAID 0 configuration for conversion to a two-drive RAID 0 configuration; however, the capacity of the resulting array must be equal to or greater than the size of the original configuration.

RAID 0 to RAID 1 conversions cannot be performed using the migrating process.

 **NOTICE:** Additional hard drives to be used in the (migrated) array must be no smaller than any of the drives in the current configuration.

 **NOTE:** Ensure that all drives to be used in the RAID configuration are RAID-enabled (see "Setting Your Computer to RAID-Enabled Mode" on page 33.)

- 1 Launch NVIDIA MediaShield.
- 2 Click to select the array you want to convert.
- 3 Click **Convert Array** in the **System Tasks** pane.
The **NVIDIA Convert Array Wizard** appears.
- 4 Click **Next**.
- 5 Under **RAID Mode Selection**, select **Mirroring**, **Striping**, **Strip Mirroring**, or **RAID 5** from the drop-down menu.
- 6 Click **Next**.

 **NOTICE:** You will lose all data on the selected drives in the next step.

- 7 Under **Free Disk Selection**, select the hard drive(s) you want to include in the (migrated) array by clicking the checkbox beside it.
- 8 Click **Finish**.

The MediaShield RAID management utility window appears and displays the status of the upgrade/migration process along with any other installed hard drives.

 **NOTE:** The time it takes to convert an array depends on several factors, such as the speed of the CPU, the type and size of the hard drive being used, the operating system, etc.

Rebuilding a RAID Configuration

If one of the hard drives in a RAID array fails, you can rebuild the array by restoring the data to a replacement drive.

 **NOTE:** Rebuilding an array can only be performed on RAID 1, RAID 5, and RAID 0+1 configurations.

- 1 Launch NVIDIA MediaShield.
- 2 Click to select your RAID configuration (**Mirroring**) in the management utility window.
- 3 Select **Rebuild Array** in the **System Tasks** pane.
The **NVIDIA Rebuild Array Wizard** appears.

- 4 Click **Next**.
- 5 Select the hard drive you want to rebuild by clicking the checkbox beside it.
- 6 Click **Next**.
- 7 Click **Finish**.

The MediaShield RAID management utility window appears and displays the status of the rebuild process.

 **NOTE:** You can use your computer while the computer is rebuilding the array.

 **NOTE:** You can use any available (RAID-enabled) free disk to rebuild an array.

Using Multimedia

 **NOTICE:** Do not press down on the optical drive tray when you open or close it. Keep the tray closed when you are not using the drive.

 **NOTICE:** Do not move the computer while playing media.



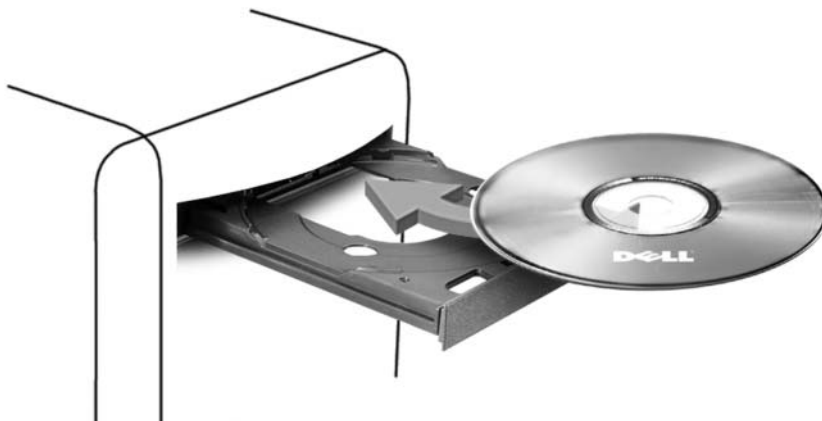





- 1 To open the tray, press the eject button on the front of the drive.
- 2 Place the disc, label side up, in the center of the tray.
- 3 To close the tray, press the eject button or gently push in the tray.













To format CDs for storing data, to create music CDs, or to copy CDs, see the CD software that came with your computer.

 **NOTE:** Ensure that you follow all copyright laws when you create media.

A CD player includes the following basic buttons:

	Play.
	Move backward within the current track.
	Pause.
	Move forward within the current track.
	Stop.
	Go to the previous track.
	Eject.
	Go to the next track.

A DVD player includes the following basic buttons:

	Stop.
	Restart the current chapter.
	Play.
	Fast forward.
	Pause.
	Fast reverse.
	Advance a single frame while in pause mode.
	Go to the next title or chapter.
	Continuously play the current title or chapter.
	Go to the previous title or chapter.
	Eject.

These controls may not exist on all players in the system. For more information on playing CDs, DVDs, or BDs, click **Help** on the media player (if available).

Copying CD, DVD, and Blu-ray Disc™ (BD) Media

This section applies only to computers that have a DVD+/-RW drive or a BD-RE drive.

 **NOTE:** Ensure that you observe all copyright laws when copying media.

 **NOTE:** The types of optical drives offered by Dell may vary by country.

The following instructions explain how to make a copy of a CD, DVD, or BD using Roxio Creator. You can also use Roxio Creator for other purposes, such as creating music CDs from audio files stored on your computer or backing up important data. For help, open Roxio Creator, and then press <F1>.

The DVD drives and BD drives installed in Dell computers do not support HD-DVD media. For a list of supported media formats, see "Using Blank CD, DVD, and BD Media" on page 39.

How to Copy a CD, DVD, or BD

 **NOTE:** BD media can only be copied to other BD media. DVD media can only be copied to other DVD-recordable/rewritable media. CD media can only be copied to other CD-recordable/rewritable media.

 **NOTE:** Copying a BD-R to BD-RE will not produce an exact copy. Border information will be lost.

 **NOTE:** Most commercial DVDs and BDs have copyright protection and cannot be copied using Roxio Creator.

- 1 Open Roxio Creator Plus.
- 2 Under the **Copy** tab, click **Disc Copy**.
- 3 To copy the CD, DVD, or BD:
 - *If you have one optical drive*, insert the source disc into the drive, ensure that the settings are correct, and then click the **Copy Disc** button to continue. The computer reads your source disc and copies the data to a temporary folder on your computer hard drive.
When prompted, insert a blank disc into the drive and click **OK**.
 - *If you have two optical drives*, select the drive into which you have inserted your source disc and click the **Copy Disc** button to continue. The computer copies the data from the source disc to the blank disc.

Once you have finished copying the source disc, the disc that you have created automatically ejects.

Using Blank CD, DVD, and BD Media

CD-writable drives can only write to CD recording media. DVD-writable drives can write to both CD and DVD recording media. BD-writable drives can write to CD, DVD and BD recording media.

Use blank CD-Rs to record music or permanently store data files. After creating a CD-R, you cannot write to that CD-R again (see the Sonic documentation for more information). Use blank CD-RWs if you plan to erase, rewrite, or update information on that disc later.

Blank DVD+/-R or BD-R media can be used to permanently store large amounts of information. After you create a DVD+/-R or BD-R, you cannot write to that disc again if the disc is "finalized" or "closed" during the final stage of the disc creation process. Use blank DVD+/-RW or BD-RE media if you plan to erase, rewrite, or update information on that disc later.

CD-Writable Drives

Media Type	Read	Write	Rewritable
CD-R	Yes	Yes	No
CD-RW	Yes	Yes	Yes

DVD-Writable Drives

Media Type	Read	Write	Rewritable
CD-R	Yes	Yes	No
CD-RW	Yes	Yes	Yes
DVD+R	Yes	Yes	No
DVD-R	Yes	Yes	No
DVD+RW	Yes	Yes	Yes
DVD-RW	Yes	Yes	Yes
DVD+R DL	Yes	Yes	No
DVD-R DL	Yes	No	No
DVD-RAM	No	No	No

BD-Writable Drives

Media Type	Read	Write	Rewritable
CD-R	Yes	Yes	No
CD-RW	Yes	Yes	Yes
DVD+R	Yes	Yes	No
DVD-R	Yes	Yes	No
DVD+RW	Yes	Yes	Yes
DVD-RW	Yes	Yes	Yes
DVD+R DL	Yes	Yes	No
DVD-R DL	Yes	No	No
DVD-RAM	No	No	No
BD-R	Yes	Yes	No
BD-RE	Yes	Yes	Yes

Helpful Tips

- Use Microsoft Windows Explorer to drag and drop files to a CD-R or CD-RW only after you start Roxio Creator and open a Creator project.
- Do not burn a blank CD-R or CD-RW to its maximum capacity; for example, do not copy a 650-MB file to a blank 650-MB CD. The CD-RW drive needs 1–2 MB of the blank space to finalize the recording.

- Use CD-Rs to burn music CDs that you want to play in regular stereos. CD-RWs do not play in most home or car stereos.
- Music MP3 files can be played only on MP3 players or on computers that have MP3 software installed.
- Use a blank CD-RW to practice CD recording until you are familiar with CD recording techniques. If you make a mistake, you can erase the data on the CD-RW and try again. You can also use blank CD-RWs to test music file projects before you record the project permanently to a blank CD-R.
- You cannot create audio DVDs with Roxio Creator.
- Commercially available DVD players used in home theater systems may not support all available DVD formats. For a list of formats supported by your DVD player, see the documentation provided with your DVD player or contact the manufacturer.
- Commercially available BD players used in home theater systems may not support all available BD formats. For a list of formats supported by your BD player, see the documentation provided with your BD player or contact the manufacturer.
- See the Roxio website at www.sonic.com for additional information.

Using a Media Card Reader (Optional)



CAUTION: Before you perform any of the procedures in this section, follow the safety instructions in the *Product Information Guide*.

Use the media card reader to transfer data directly to your computer.

The media card reader supports the following memory types:

- xD-Picture card
- SmartMedia card (SMC)
- CompactFlash card Type I and II (CF I/II)
- MicroDrive card
- SecureDigital card (SD)
- MiniSD card
- MultiMediaCard (MMC)
- Reduced-size MultiMediaCard (RS-MMC)
- Memory Stick (MS/MS Pro/MS Duo/MS Pro Duo)

For information on installing a media card reader, see "Installing a Media Card Reader" on page 121.

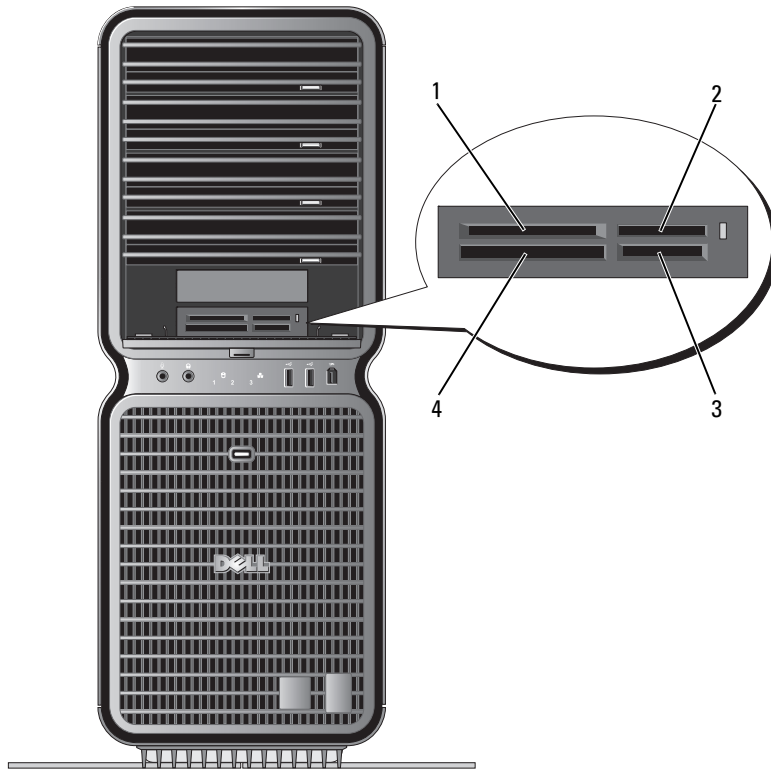

1 xD-Picture card and SmartMedia Card (SMC)

2 Memory Stick (MS/MS Pro/MS Duo/MS Pro Duo)

3 Secure Digital card (SD/miniSD)/MultiMedia-Card (MMC/RS-MMC)

4 CompactFlash card Type I and II (CF I/II) and MicroDrive card

- 1 Inspect the media card to determine the proper orientation for insertion.
- 2 Slide the media card into the appropriate slot of the media card reader until it is completely seated in the connector.

If you encounter resistance, remove the card, check for proper orientation, and then try again.

Network Setup Wizard

The Microsoft Windows operating system provides a Network Setup Wizard to guide you through the process of sharing files, printers, or an Internet connection between computers in a home or small office.

Windows XP:

- 1 Click **Start**, point to **All Programs**→**Accessories**→**Communications**, and then click **Network Setup Wizard**.
- 2 On the welcome screen, click **Next**.
- 3 Click **Checklist for creating a network**.



NOTE: Selecting the connection method **This computer connects directly to the Internet** enables the integrated firewall provided with Windows XP SP1.

- 4 Complete the checklist and required preparations.
- 5 Return to the Network Setup Wizard and follow the instructions on the screen.

Windows Vista:

- 1 Click **Start**  → **Connect to**→**Set up a connection or network**.
- 2 Select an option under **Choose a connection option**.
- 3 Click **Next** and follow the instructions in the wizard.

Transferring Information to a New Computer

You can use your operating system "wizards" to help you transfer files and other data from one computer to another—for example, from an *old* computer to a *new* computer. For instructions, see the following section that corresponds to the operating system your computer is running.

Windows XP:

To prepare the new computer for the file transfer:

- 1 Click **Start**→**All Programs**→**Accessories**→**System Tools** → **Files and Settings Transfer Wizard**.
The **Files and Settings Transfer Wizard** welcome screen appears.
- 2 Click **Next**.
- 3 On the **Which computer is this?** screen, click **New Computer**, and then click **Next**.
- 4 On the **Do you have a Windows XP CD?** screen, click **I will use the wizard from the Windows XP CD**, and then click **Next**.
- 5 When the **Now go to your old computer** screen appears, go to the source (old) computer that contains the data to be transferred. *Do not* click **Next** at this time.

To copy data from the source computer:

- 1 On the source computer, insert the Windows XP *Operating System* CD.
- 2 On the **Welcome to Microsoft Windows XP** screen, click **Perform additional tasks**.
- 3 Under **What do you want to do?**, click **Transfer files and settings**.
- 4 On the **Files and Settings Transfer Wizard** welcome screen, click **Next**.
- 5 On the **Which computer is this?** screen, click **Old Computer**, and then click **Next**.

- 6 On the **Select a transfer method** screen, click the transfer method of your preference.
- 7 On the **What do you want to transfer?** screen, select the items you want to transfer, then click **Next**. After the information has been copied, the **Completing the Collection Phase** screen appears.
- 8 Click **Finish**.

To transfer data to the new computer:

- 1 On the **Now go to your old computer** screen on the new computer, click **Next**.
- 2 On the **Where are the files and settings?** screen, select the method you chose for transferring your files and settings, and then click **Next**.

The wizard reads the collected files and settings and applies them to your new computer.

When all of the settings and files have been applied, the **Finished** screen appears.

- 3 Click **Finished** and restart the computer.

Windows Vista:

- 1 Click **Start**  → **Transfer files and settings** → **Start Windows Easy Transfer**.
- 2 In the **User Account Control** dialog box, click **Continue**.
- 3 Click **Start a new transfer** or **Continue a transfer in progress**.
- 4 Follow the instructions provided on the screen by the Windows Easy Transfer wizard.

Power Management Options in Windows XP

The Microsoft Windows XP power management features can reduce the amount of electricity your computer uses when it is on and you are not using it. You can reduce power to just the monitor or the hard drive, or you can use standby mode or hibernate mode to reduce power to the entire computer. When the computer exits from a power conservation mode, it returns to the operating state it was in prior to entering the mode.

 **NOTE:** Windows XP Professional includes security and networking features not available in Windows XP Home Edition. When a Windows XP Professional computer is connected to a network, different options related to security and networking appear in certain windows.

 **NOTE:** The procedures to activate the standby and hibernate modes may vary according to your operating system.

Standby Mode

Standby mode conserves power by turning off the display and the hard drive after a designated period of time, known as a time-out. When the computer exits from standby mode, it returns to the operating state it was in prior to entering standby mode.

 **NOTICE:** If your computer loses power while in standby mode, it may lose data.

To set standby mode to automatically activate after a defined period of inactivity:

- 1 Click **Start** and click **Control Panel**.
- 2 Under **Pick a category**, click **Performance and Maintenance**.
- 3 Under or pick a **Control Panel icon**, click **Power Options**.

To immediately activate standby mode without a period of inactivity, click **Start**→ **Turn Off Computer**→ **Stand by**.

To exit from standby mode, press a key on the keyboard or move the mouse.

Hibernate Mode

Hibernate mode conserves power by copying system data to a reserved area on the hard drive, and then completely turning off the computer. When the computer exits from hibernate mode, the desktop is restored to the state it was in prior to entering hibernate mode.

To activate hibernate mode:

- 1 Click **Start** and click **Control Panel**.
- 2 Under **Pick a category**, click **Performance and Maintenance**.
- 3 Under or pick a **Control Panel icon**, click **Power Options**.
- 4 Define your hibernate settings on the **Power Schemes** tab, **Advanced** tab, and **Hibernate** tab.

To exit from hibernate mode, press the power button. The computer may take a short time to exit from hibernate mode. Because the keyboard and mouse do not function in hibernate mode, pressing a key on the keyboard or moving the mouse does not bring the computer out of hibernation.

Because hibernate mode requires a special file on your hard drive with enough disk space to store the contents of the computer memory, Dell creates an appropriately sized hibernate mode file before shipping the computer to you. If the computer's hard drive becomes corrupted, Windows XP recreates the hibernate file automatically.

Power Options Properties

Define your standby mode settings, hibernate mode settings, and other power settings in the **Power Options Properties** window. To access the **Power Options Properties** window:

- 1 Click **Start** and click **Control Panel**.
- 2 Under **Pick a category**, click **Performance and Maintenance**.
- 3 Under or pick a **Control Panel icon**, click **Power Options**.
- 4 Define your power settings on the **Power Schemes** tab, **Advanced** tab, and **Hibernate** tab.

Power Schemes Tab

Each standard power setting is called a scheme. If you want to select one of the standard Windows schemes installed on your computer, choose a scheme from the **Power schemes** drop-down menu. The settings for each scheme appear in the fields below the scheme name. Each scheme has different settings for starting standby mode, hibernate mode, turning off the monitor, and turning off the hard drive.



NOTICE: If you set the hard drive to time-out before the monitor does, your computer may appear to be locked up. To recover, press any key on the keyboard or click the mouse. To avoid this problem, always set the monitor to time-out before the hard drive.

The **Power schemes** drop-down menu displays the following schemes:

- **Always On** (default) — If you want to use your computer with no power conservation.
- **Home/Office Desk** — If you want your home or office computer to run with little power conservation.
- **Portable/Laptop** — If your computer is a portable computer that you use for traveling.
- **Presentation** — If you want your computer to run without interruption (using no power conservation).
- **Minimal Power Management** — If you want your computer to run with minimal power conservation.
- **Max Battery** — If your computer is a portable computer and you run your computer from batteries for extended periods of time.

If you want to change the default settings for a scheme, click the drop-down menu in the **Turn off monitor**, **Turn off hard disks**, **System stand by**, or **System hibernates** field, and then select a time-out from the displayed list. Changing the time-out for a scheme field permanently changes the default settings for that scheme, unless you click **Save As** and enter a new name for the changed scheme.

Advanced Tab

The **Advanced** tab allows you to:

- Place the power options icon  in the Windows taskbar for quick access.
- Set the computer to prompt you for your Windows password before the computer exits from standby mode or hibernate mode.
- Program the power button to activate standby mode, activate hibernate mode, or turn off the computer.

To program these functions, click an option from the corresponding drop-down menu and click **OK**.

Hibernate Tab

The **Hibernate** tab allows you to enable hibernate mode. If you want to use the hibernate settings as defined on the **Power Schemes** tab, click the **Enable hibernate support** check box on the **Hibernate** tab.

For more information on power management options:

- 1 Click **Start** and click **Help and Support**.
- 2 In the **Help and Support** window, click **Performance and maintenance**.
- 3 In the **Performance and maintenance** window, click **Conserving power on your computer**.

Power Management Options in Windows Vista

The Microsoft Vista power management features can reduce the amount of electricity your computer uses when it is on and you are not using it. You can reduce power to just the monitor or the hard drive, or you can use sleep mode or hibernate mode to reduce power to the entire computer. When the computer exits from a power conservation mode, it returns to the operating state it was in prior to entering the mode.

Sleep Mode

Sleep mode conserves power by turning off the display and the hard drive after a predetermined period of inactivity (a time-out). When the computer exits sleep mode, it returns to the same operating state it was in before entering sleep mode.

To enter sleep mode in Windows Vista, click **Start** , click the arrow in the lower-right corner of the Start menu, and then click **Sleep**.

To exit sleep mode, press a key on the keyboard or move the mouse.

Hibernate Mode

Hibernate mode conserves power by copying system data to a reserved area on the hard drive and then completely turning off the computer. When the computer exits hibernate mode, it returns to the same operating state it was in before entering hibernate mode.

To manually enter hibernate mode in Windows Vista, click **Start** , click the arrow in the lower-right corner of the Start menu, and then click **Hibernate**.

Configuring Power Management Settings

You can use the Windows Power Options Properties to configure the power management settings on your computer.

To access Power Options Properties, click **Start**  → **Control Panel** → **System and Maintenance** → **Power Options**.

Optimizing for Greater Performance

Understanding Dual-Graphics Technology

With dual-graphics technology, an optional second PCI Express graphics card will significantly increase graphics performance on your computer. Benefits of this technology can be seen in the improved portrayal of the 3-D graphics used in gaming and design applications.

Each graphics card includes at least one GPU (graphics processing unit). In dual graphics card configurations, multiple GPUs dynamically share their workload to provide the best possible performance. For a given application, the software selects the optimum rendering (processing) mode.

For more information about your graphics card, go to support.dell.com.

Understanding CPU Overclocking

- ➔ **NOTICE:** Dell does not recommend operating the processor or other system components beyond the factory default settings. This may cause system instability and reduce the operating life of your system components.
- ➔ **NOTICE:** Dell Technical Support will verify the full functionality of the CPU at the factory default setting and support the CPU performance settings available within the system BIOS. Dell does not provide technical support for any hardware or software issues arising from any third party applications used to enable overclocking, such as NVIDIA nTune 5.0.

Overclocking is the process of causing a computer component to run faster than designed or designated by the component manufacturer. Depending upon your application (such as gaming or video editing), your performance may benefit from overclocking different subsystems within your computer.

The Dell™ XPS™ 720 H₂C™ Edition ships with an overclocked Intel® Core™2 Extreme Edition processor and an H₂Ceramic (also called H₂C™ or Hot-to-Cold) cooling system designed to improve overall thermal capacity.

The processor has been overclocked through CPU multiplier overclocking via the BIOS to speeds faster than the standard speed of the processor.

You can make limited adjustments to the CPU operating frequency in system setup. For more information on accessing system setup, see "System Setup" on page 168. For information on performance options, see "Performance" on page 171.

Dell™ QuickSet

 **NOTE:** This feature may not be available on your computer.

Dell™ QuickSet allows you to select and adjust LED light effects, also known as LightFX™.

You can start QuickSet by either *clicking*, *double-clicking*, or *right-clicking* the QuickSet icon in the Microsoft® Windows® taskbar. The taskbar is located in the lower-right corner of your screen.

For more information about QuickSet, right-click the QuickSet icon and select **Help**.

Troubleshooting

Solving Problems

Follow these tips when you troubleshoot your computer:

- If you added or removed a part before the problem started, review the installation procedures and ensure that the part is correctly installed.
- If a peripheral device does not work, ensure that the device is properly connected.
- If an error message appears on the screen, write down the exact message. This message may help support personnel diagnose and fix the problem(s).
- If an error message occurs in a program, see the program's documentation.



NOTE: The procedures in this document were written for the Windows default view, so they may not apply if you set your Dell™ computer to the Windows Classic view.

Battery Problems



CAUTION: There is a danger of a new battery exploding if it is incorrectly installed. Replace the battery only with the same or equivalent type recommended by the manufacturer. Discard used batteries according to the manufacturer's instructions.



CAUTION: Before you begin any of the procedures in this section, follow the safety instructions in the *Product Information Guide*.

REPLACE THE BATTERY — If you have to repeatedly reset time and date information after turning on the computer, or if an incorrect time or date displays during start-up, replace the battery (see "Replacing the Battery" on page 158). If the battery still does not work properly, contact Dell (see "Contacting Dell" on page 181).

Drive Problems



CAUTION: Before you begin any of the procedures in this section, follow the safety instructions in the *Product Information Guide*.

ENSURE THAT MICROSOFT® WINDOWS® RECOGNIZES THE DRIVE —

Windows XP:

- Click Start and click My Computer.

Windows Vista™:

- Click the Windows Vista Start button  and click Computer.

If the drive is not listed, perform a full scan with your antivirus software to check for and remove viruses. Viruses can sometimes prevent Windows from recognizing the drive.

TEST THE DRIVE —

- Insert another disc to eliminate the possibility that the original drive is defective.
- Insert a bootable floppy disk and restart the computer.

CLEAN THE DRIVE OR DISK — See "Cleaning Your Computer" on page 178.

CHECK THE CABLE CONNECTIONS

RUN THE HARDWARE TROUBLESHOOTER — See "Troubleshooting Software and Hardware Problems" on page 83.

RUN THE DELL DIAGNOSTICS — See "Dell Diagnostics" on page 72.

Optical drive problems



NOTE: High-speed optical drive vibration is normal and may cause noise, which does not indicate a defect in the drive or the media.



NOTE: Because of different regions worldwide and different disc formats, not all DVD titles work in all DVD drives.

ADJUST THE WINDOWS VOLUME CONTROL —

- Click the speaker icon in the lower-right corner of your screen.
- Ensure that the volume is turned up by clicking the slider and dragging it up.
- Ensure that the sound is not muted by clicking any boxes that are checked.

CHECK THE SPEAKERS AND SUBWOOFER — See "Sound and Speaker Problems" on page 63.

Problems writing to an optical drive

CLOSE OTHER PROGRAMS — The optical drive must receive a steady stream of data during the writing process. If the stream is interrupted, an error occurs. Try closing all programs before you write to the optical.

TURN OFF STANDBY MODE IN WINDOWS BEFORE WRITING TO A DISC — See "Configuring Power Management Settings" on page 47 or search for the keyword *standby* in Windows Help and Support for information on power management modes.

Hard drive problems

RUN CHECK DISK —

Windows XP:

- 1 Click **Start** and click **My Computer**.
- 2 Right-click **Local Disk C:**.
- 3 Click **Properties**→**Tools**→**Check Now**.
- 4 Click **Scan for and attempt recovery of bad sectors** and click **Start**.

Windows Vista:

- 1 Click **Start**  and click **Computer**.
- 2 Right-click **Local Disk C:**.

3 Click **Properties**→**Tools**→**Check Now**.

The **User Account Control** window may appear. If you are an administrator on the computer, click **Continue**; otherwise, contact your administrator to continue the desired action.

4 Follow the instructions on the screen.

E-Mail, Modem, and Internet Problems



CAUTION: Before you begin any of the procedures in this section, follow the safety instructions in the *Product Information Guide*.



NOTE: Connect the modem to an analog telephone jack only. The modem does not operate while it is connected to a digital telephone network.



NOTE: Do not plug a telephone cable into the network adapter connector (see "Back I/O Connectors" on page 17).

CHECK THE MICROSOFT OUTLOOK[®] EXPRESS SECURITY SETTINGS — If you cannot open your e-mail attachments:

- 1 In Outlook Express, click **Tools**→**Options**→**Security**.
- 2 Click **Do not allow attachments** to remove the checkmark, as needed.

CHECK THE TELEPHONE LINE CONNECTION

CHECK THE TELEPHONE JACK

CONNECT THE MODEM DIRECTLY TO THE TELEPHONE WALL JACK

USE A DIFFERENT TELEPHONE LINE —

- Verify that the telephone line is connected to the jack on the modem (the jack has either a green label or a connector-shaped icon next to it).
- Ensure that you hear a click when you insert the telephone line connector into the modem.
- Disconnect the telephone line from the modem and connect it to a telephone, then listen for a dial tone.
- If you have other telephone devices sharing the line, such as an answering machine, fax machine, surge protector, or line splitter, bypass them and use the telephone to connect the modem directly to the telephone wall jack. If you are using a line that is 3 meters (10 feet) or more in length, try a shorter one.

RUN THE MODEM DIAGNOSTIC TOOL —

Windows XP:

- 1 Click **Start**→**All Programs**→**Modem Helper**.
- 2 Follow the instructions on the screen to identify and resolve modem problems. Modem Helper is not available on certain computers.

Windows Vista:

- 1 Click **Start**  → **All Programs**→**Modem Diagnostic Tool**.
- 2 Follow the instructions on the screen to identify and resolve modem problems. Modem diagnostics are not available on all computers.

VERIFY THAT THE MODEM IS COMMUNICATING WITH WINDOWS —

Windows XP:

- 1 Click **Start** → **Control Panel** → **Printers and Other Hardware** → **Phone and Modem Options** → **Modems**.
- 2 Click the COM port for your modem → **Properties** → **Diagnostics** → **Query Modem** to verify that the modem is communicating with Windows.

If all commands receive responses, the modem is operating properly.

Windows Vista:

- 1 Click **Start**  → **Control Panel** → **Hardware and Sound** → **Phone and Modem Options** → **Modems**.
- 2 Click the COM port for your modem → **Properties** → **Diagnostics** → **Query Modem** to verify that the modem is communicating with Windows.

If all commands receive responses, the modem is operating properly.

ENSURE THAT YOU ARE CONNECTED TO THE INTERNET — Ensure that you have subscribed to an Internet provider. With the Outlook Express e-mail program open, click **File**. If **Work Offline** has a checkmark next to it, click the checkmark to remove it and connect to the Internet. For help, contact your Internet service provider.

Error Messages



CAUTION: Before you begin any of the procedures in this section, follow the safety instructions in the *Product Information Guide*.

If the error message is not listed, see the documentation for the operating system or the program that was running when the message appeared.

A FILENAME CANNOT CONTAIN ANY OF THE FOLLOWING CHARACTERS: \ / : * ? " < > | — Do not use these characters in filenames.

A REQUIRED .DLL FILE WAS NOT FOUND — The program that you are trying to open is missing an essential file. To remove and then reinstall the program:

Windows XP:

- 1 Click **Start** → **Control Panel** → **Add or Remove Programs** → **Programs and Features**.
- 2 Select the program you want to remove.
- 3 Click **Uninstall**.
- 4 See the program documentation for installation instructions.

Windows Vista:

- 1 Click **Start**  → **Control Panel** → **Programs** → **Programs and Features**.
- 2 Select the program you want to remove.
- 3 Click **Uninstall**.
- 4 See the program documentation for installation instructions.

drive letter : \ IS NOT ACCESSIBLE. THE DEVICE IS NOT READY — The drive cannot read the disk. Insert a disk into the drive and try again.

INSERT BOOTABLE MEDIA — Insert a bootable floppy disk, CD, or DVD.

NON-SYSTEM DISK ERROR — Remove the floppy disk from the floppy drive and restart your computer.

NOT ENOUGH MEMORY OR RESOURCES. CLOSE SOME PROGRAMS AND TRY AGAIN — Close all windows and open the program that you want to use. In some cases, you may have to restart your computer to restore computer resources. If so, run the program that you want to use first.

OPERATING SYSTEM NOT FOUND — Contact Dell (see "Contacting Dell" on page 181).

IEEE 1394 Device Problems



CAUTION: Before you begin any of the procedures in this section, follow the safety instructions in the *Product Information Guide*.



NOTE: Your computer supports only IEEE 1394a standard.

ENSURE THAT THE CABLE FOR THE IEEE 1394 DEVICE IS PROPERLY INSERTED INTO THE DEVICE AND INTO THE CONNECTOR ON THE COMPUTER

ENSURE THAT THE IEEE 1394 DEVICE IS ENABLED IN SYSTEM SETUP — See "System Setup Options" on page 169.

ENSURE THAT THE IEEE 1394 DEVICE IS RECOGNIZED BY WINDOWS —

Windows XP:

1 Click Start and click Control Panel.

2 Under Pick a Category, click Performance and Maintenance → System → System Properties → Hardware → Device Manager.

Windows Vista:

1 Click Start  → Control Panel → Hardware and Sound.

2 Click Device Manager.

If your IEEE 1394 device is listed, Windows recognizes the device.

IF YOU HAVE PROBLEMS WITH A DELL IEEE 1394 DEVICE — Contact Dell (see "Contacting Dell" on page 181).

IF YOU HAVE PROBLEMS WITH AN IEEE 1394 DEVICE NOT PROVIDED BY DELL — Contact the IEEE 1394 device manufacturer.

Keyboard Problems



CAUTION: Before you begin any of the procedures in this section, follow the safety instructions in the *Product Information Guide*.

CHECK THE KEYBOARD CABLE —

- Ensure that the keyboard cable is firmly connected to the computer.
- Shut down the computer (see "Preparing to Work Inside Your Computer" on page 85), reconnect the keyboard cable as shown on the setup diagram for your computer, and then restart the computer.
- Ensure that the cable is not damaged or frayed and check cable connectors for bent or broken pins. Straighten any bent pins.
- Remove any keyboard extension cables and connect the keyboard directly to the computer.

TEST THE KEYBOARD — Connect a properly working keyboard to the computer, then try using the keyboard.

RUN THE HARDWARE TROUBLESHOOTER — See "Troubleshooting Software and Hardware Problems" on page 83.

Lockups and Software Problems



CAUTION: Before you begin any of the procedures in this section, follow the safety instructions in the *Product Information Guide*.

The computer does not start up

CHECK THE DIAGNOSTIC LIGHTS — See "Diagnostic Lights" on page 66.

ENSURE THAT THE POWER CABLE IS FIRMLY CONNECTED TO THE COMPUTER AND TO THE ELECTRICAL OUTLET

The computer stops responding



NOTICE: You may lose data if you are unable to perform an operating system shutdown.

TURN THE COMPUTER OFF — If you are unable to get a response by pressing a key on your keyboard or moving your mouse, press and hold the power button for at least 8 to 10 seconds (until the computer turns off), and then restart your computer.

A program stops responding

END THE PROGRAM —

- 1 Press <Ctrl><Shift><Esc> simultaneously to access the Task Manager.
- 2 Click the Applications tab.
- 3 Click to select the program that is no longer responding.
- 4 Click End Task.

A program crashes repeatedly



NOTE: Most software includes installation instructions in its documentation or on a floppy disk, CD, or DVD.

CHECK THE SOFTWARE DOCUMENTATION — If necessary, uninstall and then reinstall the program.

A program is designed for an earlier Windows operating system

RUN THE PROGRAM COMPATIBILITY WIZARD —

Windows XP:

The Program Compatibility Wizard configures a program so that it runs in an environment similar to non-XP operating system environments.

- 1 Click Start → All Programs → Accessories → Program Compatibility Wizard → Next.
- 2 Follow the instructions on the screen.

Windows Vista:

The Program Compatibility Wizard configures a program so that it runs in an environment similar to non-Windows Vista operating system environments.

- 1 Click Start  → Control Panel → Programs → Use an older program with this version of Windows.
- 2 In the welcome screen, click Next.
- 3 Follow the instructions on the screen.

A solid blue screen appears

TURN THE COMPUTER OFF — If you are unable to get a response by pressing a key on your keyboard or moving your mouse, press and hold the power button for at least 8 to 10 seconds (until the computer turns off), and then restart your computer.

Other software problems

CHECK THE SOFTWARE DOCUMENTATION OR CONTACT THE SOFTWARE MANUFACTURER FOR TROUBLESHOOTING INFORMATION —

- Ensure that the program is compatible with the operating system installed on your computer.
- Ensure that your computer meets the minimum hardware requirements needed to run the software. See the software documentation for information.
- Ensure that the program is installed and configured properly.
- Verify that the device drivers do not conflict with the program.
- If necessary, uninstall and then reinstall the program.

BACK UP YOUR FILES IMMEDIATELY

USE A VIRUS-SCANNING PROGRAM TO CHECK THE HARD DRIVE, FLOPPY DISKS, CDS, OR DVDs

SAVE AND CLOSE ANY OPEN FILES OR PROGRAMS AND SHUT DOWN YOUR COMPUTER THROUGH THE START MENU

Memory Problems



CAUTION: Before you begin any of the procedures in this section, follow the safety instructions in the *Product Information Guide*.

IF YOU RECEIVE AN INSUFFICIENT MEMORY MESSAGE —

- Save and close any open files and exit any open programs you are not using to see if that resolves the problem.
- See the software documentation for minimum memory requirements. If necessary, install additional memory (see "Installing Memory" on page 92).
- Reseat the memory modules (see "Memory" on page 90) to ensure that your computer is successfully communicating with the memory.
- Run the Dell Diagnostics (see "Dell Diagnostics" on page 72).

IF YOU EXPERIENCE OTHER MEMORY PROBLEMS —

- Reseat the memory modules (see "Memory" on page 90) to ensure that your computer is successfully communicating with the memory.
- Ensure that you are following the memory installation guidelines (see "Installing Memory" on page 92).
- Ensure that the memory you are using is supported by your computer. For more information about the type of memory supported by your computer, see "Memory" on page 163.
- Run the Dell Diagnostics (see "Dell Diagnostics" on page 72).

Mouse Problems

 **CAUTION:** Before you begin any of the procedures in this section, follow the safety instructions in the *Product Information Guide*.

CHECK THE MOUSE CABLE —

- Ensure that the cable is not damaged or frayed and check cable connectors for bent or broken pins. Straighten any bent pins.
- Remove any mouse extension cables, and connect the mouse directly to the computer.
- Verify that the mouse cable is connected as shown on the setup diagram for your computer.

RESTART THE COMPUTER —

- 1 Simultaneously press <Ctrl><Esc> to display the **Start** menu.
- 2 Press <u>, press the up- and down-arrow keys to highlight **Shut down** or **Turn Off**, and then press <Enter>.
- 3 After the computer turns off, reconnect the mouse cable as shown on the setup diagram.
- 4 Turn on the computer.

TEST THE MOUSE — Connect a properly working mouse to the computer, then try using the mouse.

CHECK THE MOUSE SETTINGS —

Windows XP

- 1 Click **Start**→ **Control Panel**→ **Mouse**.
- 2 Adjust the settings as needed.

Windows Vista:

- 1 Click **Start**  → **Control Panel**→ **Hardware and Sound**→ **Mouse**.
- 2 Adjust the settings as needed.

REINSTALL THE MOUSE DRIVER — See "Drivers" on page 75.

RUN THE HARDWARE TROUBLESHOOTER — See "Troubleshooting Software and Hardware Problems" on page 83.

Network Problems

 **CAUTION:** Before you begin any of the procedures in this section, follow the safety instructions in the *Product Information Guide*.

CHECK THE NETWORK CABLE CONNECTOR — Ensure that the network cable is firmly inserted into the network connector on the back of the computer and the network jack.

CHECK THE NETWORK LIGHTS ON THE BACK OF THE COMPUTER — If the link integrity light is off (see "Controls and Lights" on page 165), no network communication is occurring. Replace the network cable.

RESTART THE COMPUTER AND LOG ON TO THE NETWORK AGAIN

CHECK YOUR NETWORK SETTINGS — Contact your network administrator or the person who set up your network to verify that your network settings are correct and that the network is functioning.

RUN THE HARDWARE TROUBLESHOOTER — See "Troubleshooting Software and Hardware Problems" on page 83.

Power Problems

 **CAUTION:** Before you begin any of the procedures in this section, follow the safety instructions in the *Product Information Guide*.

IF THE POWER LIGHT IS GREEN AND THE COMPUTER IS NOT RESPONDING — See "Diagnostic Lights" on page 66.

IF THE POWER LIGHT IS BLINKING GREEN — The computer is in standby mode. Press a key on the keyboard, move the mouse, or press the power button to resume normal operation.

IF THE POWER LIGHT IS OFF — The computer is either turned off or is not receiving power.

- Reseat the power cable in the power connector on the back of the computer and the electrical outlet.
- Bypass power strips, power extension cables, and other power protection devices to verify that the computer turns on properly.
- Ensure that any power strips being used are plugged into an electrical outlet and are turned on.
- Ensure that the electrical outlet is working by testing it with another device, such as a lamp.
- Ensure that the main power cable and front panel cable are securely connected to the system board (see "System Board Components" on page 89).

IF THE POWER LIGHT IS BLINKING AMBER — The computer is receiving electrical power, but an internal power problem may exist.

- Ensure that the voltage selection switch is set to match the AC power at your location (if applicable).

Ensure that all components and cables are properly installed and securely connected to the system board (see "System Board Components" on page 89).

IF THE POWER LIGHT IS STEADY AMBER — A device may be malfunctioning or incorrectly installed.

- Ensure that the processor power cable is securely connected to the system board power connector (POWER2) (see "System Board Components" on page 89).
- Remove and then reinstall all memory modules (see "Memory" on page 90).
- Remove and then reinstall any expansion cards, including graphics cards (see "Removing PCI and PCI Express Cards" on page 95).

ELIMINATE INTERFERENCE — Some possible causes of interference are:

- Power, keyboard, and mouse extension cables
- Too many devices connected to the same power strip
- Multiple power strips connected to the same electrical outlet

Printer Problems

 **CAUTION:** Before you begin any of the procedures in this section, follow the safety instructions in the *Product Information Guide*.

 **NOTE:** If you need technical assistance for your printer, contact the printer's manufacturer.

CHECK THE PRINTER DOCUMENTATION — See the printer documentation for setup and troubleshooting information.

ENSURE THAT THE PRINTER IS TURNED ON

CHECK THE PRINTER CABLE CONNECTIONS —

- See the printer documentation for cable connection information.
- Ensure that the printer cables are securely connected to the printer and the computer.

TEST THE ELECTRICAL OUTLET — Ensure that the electrical outlet is working by testing it with another device, such as a lamp.

VERIFY THAT THE PRINTER IS RECOGNIZED BY WINDOWS —

Windows XP:

- 1 Click **Start** → **Control Panel** → **Printers and Other Hardware** → **View installed printers or fax printers**.
- 2 If the printer is listed, right-click the printer icon.
- 3 Click **Properties** → **Ports**. For a parallel printer, ensure that the **Print to the following port(s):** setting is **LPT1 (Printer Port)**. For a USB printer, ensure that the **Print to the following port(s):** setting is **USB**.

Windows Vista:

- 1 Click **Start**  → **Control Panel** → **Hardware and Sound** → **Printer**.
- 2 If the printer is listed, right-click the printer icon.
- 3 Click **Properties** and click **Ports**.
- 4 Adjust the settings, as needed.

REINSTALL THE PRINTER DRIVER — **SEE THE PRINTER DOCUMENTATION FOR INFORMATION ON REINSTALLING THE PRINTER DRIVER.** —

Scanner Problems



CAUTION: Before you begin any of the procedures in this section, follow the safety instructions in the *Product Information Guide*.



NOTE: If you need technical assistance for your scanner, contact the scanner's manufacturer.

CHECK THE SCANNER DOCUMENTATION — See the scanner documentation for setup and troubleshooting information.

UNLOCK THE SCANNER — Ensure that your scanner is unlocked (if the scanner has a locking tab or button).

RESTART THE COMPUTER AND TRY THE SCANNER AGAIN

CHECK THE CABLE CONNECTIONS —

- See the scanner documentation for information on cable connections.
- Ensure that the scanner cables are securely connected to the scanner and the computer.

VERIFY THAT THE SCANNER IS RECOGNIZED BY MICROSOFT WINDOWS —

Windows XP:

- 1 Click **Start** → **Control Panel** → **Printers and Other Hardware** → **Scanners and Cameras**.
- 2 If your scanner is listed, Windows recognizes the scanner.

Windows Vista:

- 1 Click **Start**  → **Control Panel** → **Hardware and Sound** → **Scanners and Cameras**.
- 2 If the scanner is listed, Windows recognizes the scanner.

REINSTALL THE SCANNER DRIVER — See the scanner documentation for instructions.

Sound and Speaker Problems

 **CAUTION:** Before you begin any of the procedures in this section, follow the safety instructions in the *Product Information Guide*.

No sound from speakers

 **NOTE:** The volume control in MP3 and other media players may override the Windows volume setting. Always check to ensure that the volume on the media player(s) has not been turned down or off.

CHECK THE SPEAKER CABLE CONNECTIONS — Ensure that the speakers are connected as shown on the setup diagram supplied with the speakers. If you purchased a sound card, ensure that the speakers are connected to the card.

ENSURE THAT THE SUBWOOFER AND THE SPEAKERS ARE TURNED ON — See the setup diagram supplied with the speakers. If your speakers have volume controls, adjust the volume, bass, or treble to eliminate distortion.

ADJUST THE WINDOWS VOLUME CONTROL — Click or double-click the speaker icon in the lower-right corner of your screen. Ensure that the volume is turned up and that the sound is not muted.

DISCONNECT HEADPHONES FROM THE HEADPHONE CONNECTOR — Sound from the speakers is automatically disabled when headphones are connected to the computer's front-panel headphone connector.

TEST THE ELECTRICAL OUTLET — Ensure that the electrical outlet is working by testing it with another device, such as a lamp.

ELIMINATE POSSIBLE INTERFERENCE — Turn off nearby fans, fluorescent lights, or halogen lamps to check for interference.

RUN THE SPEAKER DIAGNOSTICS

REINSTALL THE SOUND DRIVER — See "Drivers" on page 75.

RUN THE HARDWARE TROUBLESHOOTER — See "Troubleshooting Software and Hardware Problems" on page 83.

No sound from headphones

CHECK THE HEADPHONE CABLE CONNECTION — Ensure that the headphone cable is securely inserted into the headphone connector (see "Front and Back View of the Computer" on page 13).

ADJUST THE WINDOWS VOLUME CONTROL — Click or double-click the speaker icon in the lower-right corner of your screen. Ensure that the volume is turned up and that the sound is not muted.

Video and Monitor Problems

 **CAUTION:** Before you begin any of the procedures in this section, follow the safety instructions in the *Product Information Guide*.

 **NOTICE:** If your computer came with a PCI graphics card installed, removal of the card is not necessary when installing additional graphics cards; however, the card is required for troubleshooting purposes. If you remove the card, store it in a safe and secure location. For information about your graphics card, go to support.dell.com.

The screen is blank

 **NOTE:** For troubleshooting procedures, see the monitor's documentation.

The screen is difficult to read

CHECK THE MONITOR CABLE CONNECTION —

- Ensure that the monitor cable is connected to the correct graphics card (for dual graphics card configurations).
- If you are using the optional DVI-to-VGA adapter, ensure that the adapter is correctly attached to the graphics card and monitor.
- Ensure that the monitor cable is connected as shown on the setup diagram for your computer.
- Remove any video extension cables and connect the monitor directly to the computer.
- Swap the computer and monitor power cables to determine if the monitor's power cable is defective.
- Check the connectors for bent or broken pins (it is normal for monitor cable connectors to have missing pins).

CHECK THE MONITOR POWER LIGHT —

- If the power light is lit or blinking, the monitor has power.
- If the power light is off, firmly press the button to ensure that the monitor is turned on.
- If the power light is blinking, press a key on the keyboard or move the mouse to resume normal operation.

TEST THE ELECTRICAL OUTLET — Ensure that the electrical outlet is working by testing it with another device, such as a lamp.

CHECK THE DIAGNOSTIC LIGHTS — See "Diagnostic Lights" on page 66.

CHECK THE MONITOR SETTINGS — See the monitor documentation for instructions on adjusting the contrast and brightness, demagnetizing (degaussing) the monitor, and running the monitor self-test.

MOVE THE SUBWOOFER AWAY FROM THE MONITOR — If your speaker system includes a subwoofer, ensure that the subwoofer is positioned at least 60 centimeters (2 feet) away from the monitor.

MOVE THE MONITOR AWAY FROM EXTERNAL POWER SOURCES — Fans, fluorescent lights, halogen lamps, and other electrical devices can cause the screen image to appear shaky. Turn off nearby devices to check for interference.

ROTATE THE MONITOR TO ELIMINATE SUNLIGHT GLARE AND POSSIBLE INTERFERENCE

ADJUST THE WINDOWS DISPLAY SETTINGS —

Windows XP:

- 1 Click **Start** → **Control Panel** → **Appearance and Themes**.
- 2 Click the area you want to change or click the **Display** icon.
- 3 Try different settings for **Color quality** and **Screen resolution**.

Windows Vista:

- 1 Click **Start**  → **Control Panel** → **Hardware and Sound** → **Personalization** → **Display Settings**.
- 2 Adjust **Resolution** and **Colors** settings, as needed.

3D image quality is poor

CHECK THE GRAPHICS CARD POWER CABLE CONNECTION — Ensure that the power cable for the graphics card(s) is correctly attached to the card.

CHECK THE MONITOR SETTINGS — See the monitor documentation for instructions on adjusting the contrast and brightness, demagnetizing (degaussing) the monitor, and running the monitor self-test.

Power Lights

 **CAUTION:** Before you begin any of the procedures in this section, follow the safety instructions in the *Product Information Guide*.

The power button light located on the front of the computer illuminates and blinks or remains solid to indicate different states:

















- If the power light is green and the computer is not responding, see "Diagnostic Lights" on page 66.
- If the power light is blinking green, the computer is in standby mode. Press a key on the keyboard, move the mouse, or press the power button to resume normal operation.
- If the power light is off, the computer is either turned off or is not receiving power.
 - Reseat the power cable into both the power connector on the back of the computer and the electrical outlet.
 - If the computer is plugged into a power strip, ensure that the power strip is plugged into an electrical outlet and that the power strip is turned on.
 - Bypass power protection devices, power strips, and power extension cables to verify that the computer turns on properly.
 - Ensure that the electrical outlet is working by testing it with another device, such as a lamp.
 - Ensure that the main power cable and front panel cable are securely connected to the system board (see "System Board Components" on page 89).
- If the power light is blinking amber, the computer is receiving electrical power, but an internal power problem might exist.
 - Ensure that the voltage selection switch is set to match the AC power at your location, if applicable.
 - Ensure that the processor power cable is securely connected to the system board (see "System Board Components" on page 89).
- If the power light is steady amber, a device may be malfunctioning or incorrectly installed.
 - Remove and then reinstall the memory modules (see "Memory" on page 90).
 - Remove and then reinstall any cards (see "Cards" on page 94).
- Eliminate interference. Some possible causes of interference are:
 - Power, keyboard, and mouse extension cables
 - Too many devices on a power strip
 - Multiple power strips connected to the same electrical outlet





Diagnostic Lights



 **CAUTION:** Before you begin any of the procedures in this section, follow the safety instructions in the *Product Information Guide*.

To help troubleshoot a problem, your computer has four lights labeled 1, 2, 3, and 4 on the front panel (see "Front View" on page 13). When the computer starts normally, the lights flash before turning off. If the computer malfunctions, the sequence of the lights help to identify the problem.

 **NOTE:** After the computer completes POST, all four lights turn off before booting to the operating system.

Light Pattern	Problem Description	Suggested Resolution
   	<p>The computer is in a normal <i>off</i> condition or a possible pre-BIOS failure has occurred.</p> <p>The diagnostic lights are not lit after the system successfully boots to the operating system.</p>	<ul style="list-style-type: none">• Plug the computer into a working electrical outlet (see "Power Problems" on page 61).• If the problem persists, contact Dell (see "Contacting Dell" on page 181).
   	<p>A possible processor failure has occurred.</p>	<ul style="list-style-type: none">• Reseat the processor (see "Processor" on page 132).• If the problem persists, contact Dell (see "Contacting Dell" on page 181).
   	<p>Memory modules are detected, but a memory failure has occurred.</p>	<ul style="list-style-type: none">• If two or more memory modules are installed, remove the modules (see "Removing Memory" on page 93), then reinstall one module (see "Installing Memory" on page 92) and restart the computer. If the computer starts normally, continue to install additional memory modules (one at a time) until you have identified a faulty module or reinstalled all modules without error.• If available, install working memory of the same type into your computer (see "Installing Memory" on page 92).• If the problem persists, contact Dell (see "Contacting Dell" on page 181).
   	<p>A possible graphics card failure has occurred.</p>	<ul style="list-style-type: none">• Reseat any installed graphics cards (see "Cards" on page 94).• If available, install a working graphics card into your computer.• If the problem persists, contact Dell (see "Contacting Dell" on page 181).

Light Pattern	Problem Description	Suggested Resolution
	A possible floppy drive or hard drive failure has occurred.	Reseat all power and data cables.
	A possible USB failure has occurred.	Reinstall all USB devices and check all cable connections.
	No memory modules are detected.	<ul style="list-style-type: none"> • If two or more memory modules are installed, remove the modules (see "Removing Memory" on page 93), then reinstall one module (see "Installing Memory" on page 92) and restart the computer. If the computer starts normally, continue to install additional memory modules (one at a time) until you have identified a faulty module or reinstalled all modules without error. • If available, install working memory of the same type into your computer (see "Installing Memory" on page 92). • If the problem persists, contact Dell (see "Contacting Dell" on page 181).
	Memory modules are detected, but a memory configuration or compatibility error has occurred.	<ul style="list-style-type: none"> • Ensure that no special requirements for memory module/connector placement exist (see "Memory" on page 90). • Ensure that the memory you are using is supported by your computer (see "Memory" on page 163). • If the problem persists, contact Dell (see "Contacting Dell" on page 181).

Light Pattern	Problem Description	Suggested Resolution
	A possible expansion card failure has occurred.	<ol style="list-style-type: none"> 1 Determine if a conflict exists by removing an expansion card (not a graphics card) and restarting the computer (see "Removing PCI and PCI Express Cards" on page 95). 2 If the problem persists, reinstall the card you removed, then remove a different card and restart the computer. 3 Repeat this process for each expansion card installed. If the computer starts normally, troubleshoot the last card removed from the computer for resource conflicts (see "Troubleshooting Software and Hardware Problems" on page 83). 4 If the problem persists, contact Dell (see "Contacting Dell" on page 181).
	Another failure has occurred.	<ul style="list-style-type: none"> • Ensure that all hard drive and optical drive cables are properly connected to the system board (see "System Board Components" on page 89). • If there is an error message on the screen identifying a problem with a device (such as the floppy drive or hard drive), check the device to make sure it is functioning properly. • If the operating system is attempting to boot from a device (such as the floppy drive or optical drive), check system setup (see "System Setup" on page 168) to ensure the boot sequence is correct for the devices installed on your computer. • If the problem persists, contact Dell (see "Contacting Dell" on page 181).

Beep Codes

Your computer might emit a series of beeps during start-up if the monitor cannot display errors or problems. This series of beeps, called a beep code, identifies a problem. For example, beep code 1-3-1 (one possible beep code) consists of one beep, a burst of three beeps, and then one beep. This beep code tells you that the computer encountered a memory problem.

Reseating the memory modules may correct the following beep code errors. If the problem persists, contact Dell (see "Contacting Dell" on page 181) for instructions on obtaining technical assistance.

Code	Cause
1-3-1 through 2-4-4	Memory not being properly identified or used
4-3-1	Memory failure above address 0FFFFh

If you experience any of the following beep code errors, see "Contacting Dell" on page 181 for instructions on obtaining technical assistance.

Code	Cause
1-1-2	Microprocessor register failure
1-1-3	NVRAM read/write failure
1-1-4	ROM BIOS checksum failure
1-2-1	Programmable interval timer failure
1-2-2	DMA initialization failure
1-2-3	DMA page register read/write failure
1-3	Video Memory Test failure
1-3-1 through 2-4-4	Memory not being properly identified or used
3-1-1	Slave DMA register failure
3-1-2	Master DMA register failure
3-1-3	Master interrupt mask register failure
3-1-4	Slave interrupt mask register failure
3-2-2	Interrupt vector loading failure
3-2-4	Keyboard Controller Test failure
3-3-1	NVRAM power loss
3-3-2	Invalid NVRAM configuration
3-3-4	Video Memory Test failure
3-4-1	Screen initialization failure

Code	Cause
3-4-2	Screen retrace failure
3-4-3	Search for video ROM failure
4-2-1	No timer tick
4-2-2	Shutdown failure
4-2-3	Gate A20 failure
4-2-4	Unexpected interrupt in protected mode
4-3-1	Memory failure above address 0FFFFh
4-3-3	Timer-chip counter 2 failure
4-3-4	Time-of-day clock stopped
4-4-1	Serial or parallel port test failure
4-4-2	Failure to decompress code to shadowed memory
4-4-3	Math-coprocessor test failure
4-4-4	Cache test failure

System Messages



NOTE: If the message you received is not listed in the table, see the documentation for either the operating system or the program that was running when the message appeared.

Message	Possible Cause	Corrective Action
8042 Gate-A20 error	The keyboard controller failed its test.	If you receive this message after you make changes in the system setup program, enter the system setup program and restore the original value(s).
Address Line Short!	An error in the address decoding circuitry in the memory has occurred.	Reseat the memory modules (see "Memory" on page 90).
C: Drive Error C: Drive Failure	The hard drive is not working or is not configured correctly.	Ensure that the hard drive is installed correctly in the computer (see "Hard Drive" on page 108) and defined correctly in the system setup program (see "System Setup" on page 168).
Cache Memory Bad, Do Not Enable Cache	The cache memory is not operating.	See "Contacting Dell" on page 181 for instructions on obtaining technical assistance.

Message	Possible Cause	Corrective Action
CH-2 Timer Error	An error is occurring on the timer on the system board.	See "Contacting Dell" on page 181 for instructions on obtaining technical assistance.
CMOS Battery State Low	The system configuration information in the system setup program is incorrect or the battery charge may be low.	Enter the system setup program (see "Entering System Setup" on page 168), verify the system configuration, and then restart the computer.
CMOS Checksum Failure		
CMOS System Options Not Set		
CMOS Display Type Mismatch		
CMOS Memory Size Mismatch		
CMOS Time and Date Not Set		
Diskette Boot Failure	Drive A or B is present but has failed the BIOS POST.	Ensure that the drive is installed correctly in the computer (see "Drives" on page 106) and defined correctly in the system setup program (see "System Setup" on page 168). Check the interface cable at both ends.
DMA Error	Error in the DMA controller on the system board.	The keyboard or system board may need to be replaced.
DMA 1 Error		
DMA 2 Error		
FDD Controller Failure	The BIOS cannot communicate with the floppy drive or hard drive controller.	Ensure that the floppy drive or the hard drive is installed correctly in the computer (see "Drives" on page 106) and defined correctly in the system setup program (see "System Setup" on page 168). Check the interface cable at both ends.
HDD Controller Failure		
INTR1 Error	An interrupt channel on the system board failed to POST.	The keyboard or system board may need to be replaced.
INTR2 Error		
Invalid Boot Diskette	The operating system cannot be located on drive A or drive C.	Enter the system setup program (see "System Setup" on page 168) and confirm that drive A or drive C is properly identified.

Message	Possible Cause	Corrective Action
Keyboard Error	The BIOS has detected a stuck key.	Ensure that nothing is resting on the keyboard; if a key appears to be stuck, carefully pry it up. If the problem persists, you may need to replace the keyboard.
KB/Interface Error	An error occurred with the keyboard connector.	Ensure that nothing is resting on the keyboard; if a key appears to be stuck, carefully pry it up. If the problem persists, you may need to replace the keyboard.
No ROM Basic	The operating system cannot be located on drive A or drive C.	Enter the system setup program (see "Entering System Setup" on page 168) and confirm that drive A or drive C is properly identified.

Dell Diagnostics

 **CAUTION:** Before you begin any of the procedures in this section, follow the safety instructions in the *Product Information Guide*.

When to Use Dell Diagnostics

If you experience a problem with your computer, perform the checks in "Solving Problems" on page 53 and run Dell Diagnostics before you contact Dell for technical assistance.

 **NOTE:** Dell Diagnostics only operate on Dell computers.

Run Dell Diagnostics from your hard drive or from the *Drivers and Utilities* media.

Starting Dell Diagnostics From Your Hard Drive

- 1 Turn on (or restart) your computer.
- 2 When the DELL logo appears, press <F12> immediately.

 **NOTE:** Keyboard failure may result when a key is held down for extended periods of time. To avoid possible keyboard failure, press and release <F12> in even intervals to open the **Boot Device Menu**.

 **NOTE:** If at any time a message appears stating that no diagnostics utility partition has been found, run Dell Diagnostics from your *Drivers and Utilities* media (see "Starting Dell Diagnostics From the Drivers and Utilities Media" on page 73).

If you wait too long and the operating system logo appears, continue to wait until you see the Microsoft® Windows® desktop, then shut down your computer and try again.

- 3 At the **Boot Device Menu**, use the up- and down-arrow keys or press the appropriate number on the keyboard to highlight **Boot to Utility Partition**, and then press <Enter>.

 **NOTE:** The Quickboot feature changes the boot sequence for the current boot only. Upon restart, the computer boots according to the boot sequence specified in system setup.

- 4 At the Dell Diagnostics **Main Menu**, left-click with the mouse, or press <Tab> and then <Enter>, to select the test you want to run (see "Dell Diagnostics Main Menu" on page 74).

 **NOTE:** Write down any error codes and problem descriptions exactly as they appear and follow the instructions on the screen.

- 5 After all tests have completed, close the test window to return to the Dell Diagnostics **Main Menu**.
- 6 Close the **Main Menu** window to exit Dell Diagnostics and restart the computer.

Starting Dell Diagnostics From the Drivers and Utilities Media

- 1 Turn on your computer.
- 2 Press the eject button on the front of the optical drive to open the drive tray.
- 3 Place the *Drivers and Utilities* media in the center of the drive tray, then press the eject button or gently push on the tray to close it.
- 4 Restart the computer.
- 5 When the DELL logo appears, press <F12> immediately.

 **NOTE:** Keyboard failure may result when a key on the keyboard is held down for extended periods of time. To avoid possible keyboard failure, press and release <F12> in even intervals until the **Boot Device Menu** appears.

If you wait too long and the Windows logo appears, continue to wait until you see the Windows desktop, then shut down your computer and try again.

- 6 At the **Boot Device Menu**, use the up- and down-arrow keys or press the appropriate number on the keyboard to highlight **Onboard or USB CD-ROM**, and then press <Enter>.

 **NOTE:** The Quickboot feature changes the boot sequence for the current boot only. Upon restart, the computer boots according to the boot sequence specified in system setup.

- 7 At the **CD-ROM Startup Menu**, use the up- and down-arrow keys or press the appropriate number on the keyboard to highlight **Boot from CD-ROM**, and then press <Enter>.

If you wait too long and the Windows logo appears, continue to wait until you see the Windows desktop, then shut down your computer and try again.

- 8 Press <1> to select the Dell Diagnostics.
- 9 At the **Dell Diagnostics Menu**, press <1> to select Dell Diagnostics (graphical user interface).
- 10 At the Dell Diagnostics **Main Menu**, left-click with the mouse, or press <Tab> and then <Enter>, to select the test you want to run (see "Dell Diagnostics Main Menu" on page 74).

 **NOTE:** Write down any error codes and problem descriptions exactly as they appear and follow the instructions on the screen.

- 11 After all tests have completed, close the test window to return to the Dell Diagnostics **Main Menu**.
- 12 Remove the *Drivers and Utilities* media, then close the **Main Menu** window to exit Dell Diagnostics and restart the computer.

Dell Diagnostics Main Menu

The following tests can be run from the Dell Diagnostics **Main Menu**:

Option	Function
Express Test	Performs a quick test of system devices. The test typically takes 10 to 20 minutes and requires no interaction on your part. Run Express Test first to increase the possibility of tracing the problem quickly.
Extended Test	Performs a thorough check of system devices. The test typically takes an hour or more and periodically requires your input to answer specific questions.
Custom Test	Tests a specific device in the system and can be used to customize the tests you want to run.
Symptom Tree	Lists a number of common symptoms and allows you to select a test based on the symptom of the problem you are having.

For any problem encountered during a test, a message appears with an error code and a description of the problem. Write down the error code and problem description exactly as it appears and follow the instructions on the screen. If you cannot resolve the problem, contact Dell (see "Contacting Dell" on page 181).

 **NOTE:** The Service Tag for your computer is located at the top of each test screen. When contacting Dell support, have your Service Tag ready.

The following tabs provide additional information for tests run from the **Custom Test** or **Symptom Tree** option:

Tab	Function
Results	Displays the results of the test and any error conditions encountered.
Errors	Displays error conditions encountered, error codes, and the problem description.
Help	Describes the test and any requirements for running the test.
Configuration (Custom Test only)	Displays the hardware configuration for the selected device. The Dell Diagnostics obtains configuration information for all devices from system setup, memory, and various internal tests, and it displays the information in the device list in the left pane of the screen. NOTE: The device list may not display the names of all the components installed on your computer or all devices attached to your computer.

Tab	Function
Parameters (Custom Test only)	Allows you to customize the test, if applicable, by changing the test settings.

Drivers

What Is a Driver?

A driver is a program that controls a device such as a printer, mouse, or keyboard. All devices require a driver program.

A driver acts like a translator between the device and any other programs that use the device. Each device has its own set of specialized commands that only its driver recognizes.

Dell ships your computer to you with required drivers already installed—no further installation or configuration is needed.

 **NOTICE:** The *Drivers and Utilities* media may contain drivers for operating systems that are not on your computer. Ensure that you are installing software appropriate for your operating system.

Many drivers, such as the keyboard driver, come with your Microsoft Windows operating system. You may need to install drivers if you:

- Upgrade your operating system.
- Reinstall your operating system.
- Connect or install a new device.

Identifying Drivers

If you experience a problem with any device, identify whether the driver is the source of your problem and, if necessary, update the driver.

Windows XP:

- 1 Click **Start** and click **Control Panel**.
- 2 Under **Pick a Category**, click **Performance and Maintenance**→ **System**→ **Hardware** → **Device Manager**.
- 3 Scroll down the list of devices and check for an exclamation point (a circle with a [!]) next to the device name.

If an exclamation point appears next to the device name, you may need to reinstall the driver or install a new driver (see "Drivers" on page 75).

Windows Vista:

- 1 Click **Start**  → **Computer**→ **System Properties**→ **Device Manager**.

 **NOTE:** The **User Account Control** window may appear. If you are an administrator on the computer, click **Continue**; otherwise, contact your administrator to continue.

- 2 Scroll down the list to see if any device has an exclamation point (a yellow circle with a [!]) on the device icon.

If an exclamation point is next to the device name, you may need to reinstall the driver or install a new driver (see "Reinstalling Drivers and Utilities" on page 76).

Reinstalling Drivers and Utilities



NOTICE: The Dell Support website at support.dell.com and your *Drivers and Utilities* media provide approved drivers for Dell™ computers. If you install drivers obtained from other sources, your computer might not work correctly.



Using Windows Device Driver Rollback

If a problem occurs on your computer after you install or update a driver, use Windows Device Driver Rollback to replace the driver with the previously installed version.

Windows XP:

- 1 Click **Start** and click **Control Panel**.
- 2 Under **Pick a Category**→ **Performance and Maintenance**→ **System**→ **System Properties**→ **Hardware**→ **Device Manager**.
- 3 Right-click the device for which the new driver was installed, then click **Properties**.
- 4 Click **Driver** and click **Roll Back Driver**.

Windows Vista:

- 1 Click **Start**  → **Computer**→ **System Properties**→ **Device Manager**.
 **NOTE:** The **User Account Control** window may appear. If you are an administrator on the computer, click **Continue**; otherwise, contact your administrator to enter the Device Manager.
- 2 Right-click the device for which the new driver was installed and click **Properties**.
- 3 Click **Drivers** and click **Roll Back Driver**.

If Device Driver Rollback does not resolve the problem, then use System Restore to return your computer to the operating state that existed before you installed the driver.

Using the Drivers and Utilities Media

If using Device Driver Rollback or System Restore does not resolve the problem, then reinstall the driver from the *Drivers and Utilities* media.

- 1 With the Windows desktop displayed, insert the *Drivers and Utilities* media.
If this is your first time to use the *Drivers and Utilities* media, go to step 2. If not, go to step 5.
- 2 When the *Drivers and Utilities* installation program starts, follow the prompts on the screen.
- 3 When the **InstallShield Wizard Complete** window appears, remove the *Drivers and Utilities* media and click **Finish** to restart the computer.

4 When you see the Windows desktop, reinsert the *Drivers and Utilities* media.

5 At the **Welcome Dell System Owner** screen, click **Next**.



NOTE: The *Drivers and Utilities* media displays drivers only for hardware that came installed in your computer. If you installed additional hardware, the drivers for the new hardware might not be displayed by the *Drivers and Utilities* media. If those drivers are not displayed, exit the *Drivers and Utilities* media program. For drivers information, see the documentation that came with the device.

A message appears, stating that the Drivers and Utilities media is detecting hardware in your computer.

The drivers that are used by your computer are automatically displayed in the **My Drivers—The Drivers and Utilities media has identified these components in your system** window.

6 Click the driver that you want to reinstall and follow the instructions on the screen.

If a particular driver is not listed, that driver is not required by your operating system.

Manually Reinstalling Drivers

After extracting driver files from the *Drivers and Utilities* media to your hard drive, you may be required to update the driver manually.

Windows XP:

1 Click **Start** and click **Control Panel**.

2 Under **Pick a Category**, click **Performance and Maintenance**→ **System**→ **System Properties**→ **Hardware**→ **Device Manager**.

3 Double-click the type of device for which you are installing the driver.

4 Right-click the device for which the driver is being reinstalled, then click **Properties**.

5 Click **Driver**→ **Update Driver**→ **Install from a list or specific location (Advanced)**→ **Next**.

6 Click to check **Include this location in the search**, then click **Browse** and navigate to where the driver files are located on your hard drive.

7 When the name of the appropriate driver appears, click **Next**.

8 Click **Finish** and restart your computer.

Windows Vista:

1 Click **Start**  → **Computer**→ **System Properties**→ **Device Manager**.



NOTE: The **User Account Control** window may appear. If you are an administrator on the computer, click **Continue**; otherwise, contact your administrator to enter the Device Manager.

2 Double-click the type of device for which you are installing the driver (for example, **Audio** or **Video**).

3 Double-click the name of the device for which you are installing the driver.

4 Click **Driver**→ **Update Driver**→ **Browse my computer for driver software**.

5 Click **Browse** and browse to the location to which you previously copied the driver files.

- 6 When the name of the appropriate driver appears, click the name of the driver.
- 7 Click **OK**→**Next**→**Finish** and restart your computer.

Restoring Your Operating System

You can restore your operating system in the following ways:

- System Restore returns your computer to an earlier operating state without affecting data files. Use System Restore as the first solution for restoring your operating system and preserving data files.
- Dell PC Restore by Symantec (available in Windows XP) and Dell Factory Image Restore (available in Windows Vista) restore your hard drive to the operating state it was in when you purchased the computer. Both permanently delete all data on the hard drive and remove any programs installed after you received the computer. Use Dell PC Restore or Dell Factory Image Restore only if System Restore did not resolve your operating system problem.
- If you received an *Operating System* disc with your computer, you can use it to restore your operating system. However, using the *Operating System* disc also deletes all data on the hard drive. Use the disc *only* if System Restore did not resolve your operating system problem.

Using Microsoft Windows System Restore

The Windows operating systems provide a System Restore option which allows you to return your computer to an earlier operating state (without affecting data files) if changes to the hardware, software, or other system settings have left the computer in an undesirable operating state. Any changes that System Restore makes to your computer are completely reversible.



NOTICE: Make regular backups of your data files. System Restore does not monitor your data files or recover them.



NOTE: The procedures in this document were written for the Windows default view, so they may not apply if you set your Dell™ computer to the Windows Classic view.

Starting System Restore



Windows XP:



NOTICE: Before you restore the computer to an earlier operating state, save and close any open files and exit any open programs. Do not alter, open, or delete any files or programs until the system restoration is complete.

- 1 Click **Start**→**All Programs**→**Accessories**→**System Tools**→**System Restore**.
- 2 Click either **Restore my computer to an earlier time** or **Create a restore point**.
- 3 Click **Next** and follow the remaining on-screen prompts.

Windows Vista:

- 1 Click **Start** .
- 2 In the Start Search box, type `System Restore` and press <Enter>.
 **NOTE:** The **User Account Control** window may appear. If you are an administrator on the computer, click **Continue**; otherwise, contact your administrator to continue the desired action.
- 3 Click **Next** and follow the remaining prompts on the screen.

In the event that System Restore did not resolve the issue, you may undo the last system restore.

Undoing the Last System Restore

-  **NOTICE:** Before you undo the last system restore, save and close all open files and exit any open programs. Do not alter, open, or delete any files or programs until the system restoration is complete.

Windows XP:

- 1 Click **Start**→ **All Programs**→ **Accessories**→ **System Tools**→ **System Restore**.
- 2 Click **Undo my last restoration** and click **Next**.

Windows Vista:

- 1 Click **Start** .
- 2 In the Start Search box, type `System Restore` and press <Enter>.
- 3 Click **Undo my last restoration** and click **Next**.

Enabling System Restore

-  **NOTE:** Windows Vista does not disable System Restore; regardless of low disk space. Therefore, the steps below apply only to Windows XP.

If you reinstall Windows XP with less than 200 MB of free hard-disk space available, System Restore is automatically disabled.

To see if System Restore is enabled:

- 1 Click **Start**→ **Control Panel**→ **Performance and Maintenance**→ **System**.
- 2 Click the **System Restore** tab and ensure that **Turn off System Restore** is unchecked.

Using Dell PC Restore and Dell Factory Image Restore

-  **NOTICE:** Using Dell PC Restore or Dell Factory Image Restore permanently deletes all data on the hard drive and removes any programs or drivers installed after you received your computer. If possible, back up the data before using these options. Use PC Restore or Dell Factory Image Restore only if System Restore did not resolve your operating system problem.

-  **NOTE:** Dell PC Restore by Symantec and Dell Factory Image Restore may not be available in certain countries or on certain computers.

Use Dell PC Restore (Windows XP) or Dell Factory Image Restore (Windows Vista) only as the last method to restore your operating system. These options restore your hard drive to the operating state it was in when you purchased the computer. Any programs or files added since you received your computer—including data files—are permanently deleted from the hard drive. Data files include documents, spreadsheets, e-mail messages, digital photos, music files, and so on. If possible, back up all data before using PC Restore or Factory Image Restore.

Windows XP: Dell PC Restore

Using PC Restore:

- 1 Turn on the computer.

During the boot process, a blue bar with www.dell.com appears at the top of the screen.

- 2 Immediately upon seeing the blue bar, press <Ctrl><F11>.

If you do not press <Ctrl><F11> in time, let the computer finish starting, and then restart the computer again.



NOTICE: If you do not want to proceed with PC Restore, click **Reboot**.

- 3 Click **Restore** and click **Confirm**.

The restore process takes approximately 6 to 10 minutes to complete.

- 4 When prompted, click **Finish** to reboot the computer.



NOTE: Do not manually shut down the computer. Click **Finish** and let the computer completely reboot.

- 5 When prompted, click **Yes**.

The computer restarts. Because the computer is restored to its original operating state, the screens that appear, such as the End User License Agreement, are the same ones that appeared the first time the computer was turned on.

- 6 Click **Next**.

The **System Restore** screen appears and the computer restarts.

- 7 After the computer restarts, click **OK**.

Removing PC Restore:



NOTICE: Removing Dell PC Restore from the hard drive permanently deletes the PC Restore utility from your computer. After you have removed Dell PC Restore, you will not be able to use it to restore your computer operating system.

Dell PC Restore enables you to restore your hard drive to the operating state it was in when you purchased your computer. It is recommended that you *do not* remove PC Restore from your computer, even to gain additional hard-drive space. If you remove PC Restore from the hard drive, you cannot ever recall it, and you will never be able to use PC Restore to return your computer operating system to its original state.

- 1 Log on to the computer as a local administrator.
- 2 In Microsoft Windows Explorer, go to `c:\dell\utilities\DSR`.
- 3 Double-click the filename `DSRIRRemv2.exe`.

 **NOTE:** If you do not log on as a local administrator, a message appears stating that you that you must log on as administrator. Click **Quit**, and then log on as a local administrator.

 **NOTE:** If the partition for PC Restore does not exist on your computer hard drive, a message appears stating that the partition was not found. Click **Quit**; there is no partition to delete.

- 4 Click **OK** to remove the PC Restore partition on the hard drive.
- 5 Click **Yes** when a confirmation message appears.
The PC Restore partition is deleted and the newly available disk space is added to the free space allocation on the hard drive.
- 6 Right-click **Local Disk (C)** in Windows Explorer, click **Properties**, and verify that the additional disk space is available as indicated by the increased value for **Free Space**.
- 7 Click **Finish** to close the **PC Restore Removal** window and restart the computer.

Windows Vista: Dell Factory Image Restore

Using Factory Image Restore:

- 1 Turn on the computer. When the Dell logo appears, press <F8> several times to access the Vista Advanced Boot Options Window.
- 2 Select **Repair Your Computer**.
The System Recovery Options window appears.
- 3 Select a keyboard layout and click **Next**.
- 4 To access the recovery options, log on as a local user. To access the command prompt, type `administrator` in the User name field, then click **OK**.
- 5 Click **Dell Factory Image Restore**.

 **NOTE:** Depending upon your configuration, you may need to select **Dell Factory Tools**, then **Dell Factory Image Restore**.

The Dell Factory Image Restore welcome screen appears.

- 6 Click **Next**.
The Confirm Data Deletion screen appears.

 **NOTICE:** If you do not want to proceed with Factory Image Restore, click **Cancel**.

- 7 Click the checkbox to confirm that you want to continue reformatting the hard drive and restoring the system software to the factory condition, then click **Next**.

The restore process begins and may take five or more minutes to complete. A message appears when the operating system and factory-installed applications have been restored to factory condition.

- 8 Click **Finish** to reboot the system.

Using the Operating System Media

Before you Begin

If you are considering reinstalling the Windows operating system to correct a problem with a newly installed driver, first try using Windows Device Driver Rollback. See "Using Windows Device Driver Rollback" on page 76. If Device Driver Rollback does not resolve the problem, then use System Restore to return your operating system to the operating state it was in before you installed the new device driver. See "Using Microsoft Windows System Restore" on page 78.

 **NOTICE:** Before performing the installation, back up all data files on your primary hard drive. For conventional hard drive configurations, the primary hard drive is the first drive detected by the computer.

To reinstall Windows, you need the following items:

- Dell™ *Operating System* media
- Dell *Drivers and Utilities* media

 **NOTE:** The Dell *Drivers and Utilities* media contains drivers that were installed during the assembly of the computer. Use the Dell *Drivers and Utilities* media to load any required drivers. Depending on the region from which you ordered your computer, or whether you requested the media, the Dell *Drivers and Utilities* media and *Operating System* media may not ship with your computer.

Reinstalling Windows XP or Windows Vista

The reinstallation process can take 1 to 2 hours to complete. After you reinstall the operating system, you must also reinstall the device drivers, virus protection program, and other software.

 **NOTICE:** The *Operating System* media provides options for reinstalling Windows XP. The options can overwrite files and possibly affect programs that are installed on your hard drive. Therefore, do not reinstall Windows XP unless a Dell technical support representative instructs you to do so.

- 1 Save and close any open files and exit any open programs.
- 2 Insert the *Operating System* disc.
- 3 Click **Exit** if the **Install Windows** message appears.
- 4 Restart the computer.

When the DELL logo appears, press <F12> immediately.

 **NOTE:** If you wait too long and the operating system logo appears, continue to wait until you see the Microsoft® Windows® desktop; then, shut down your computer and try again.



NOTE: The next steps change the boot sequence for one time only. On the next start-up, the computer boots according to the devices specified in the system setup program.

- 5 When the boot device list appears, highlight **CD/DVD/CD-RW Drive** and press <Enter>.
- 6 Press any key to **Boot from CD-ROM**.
- 7 Follow the instructions on the screen to complete the installation.

Troubleshooting Software and Hardware Problems

If a device is either not detected during the operating system setup or is detected but incorrectly configured, you can use the Hardware Troubleshooter to resolve the incompatibility.

Windows XP:

- 1 Click **Start** and click **Help and Support**.
- 2 Type `hardware troubleshooter` in the **Search** field and click the arrow to start the search.
- 3 Click **Hardware Troubleshooter** in the **Search Results** list.
- 4 In the **Hardware Troubleshooter** list, click **I need to resolve a hardware conflict on my computer**, and click **Next**.

Windows Vista:

- 1 Click **Start**  and click **Help and Support**.
- 2 Type `hardware troubleshooter` in the search field and press <Enter> to start the search.
- 3 In the search results, select the option that best describes the problem and follow the remaining troubleshooting steps.

Removing and Installing Parts

Before You Begin

This chapter provides procedures for removing and installing the components in your computer. Unless otherwise noted, each procedure assumes that a component can be replaced by performing the removal procedure in reverse order.





Recommended Tools

The procedures in this document may require one or more of the following tools:

- Small flat-blade screwdriver
- Phillips screwdriver
- Flash BIOS update (see the Dell support website at support.dell.com)

Preparing to Work Inside Your Computer

Use the following safety guidelines to help protect your computer from potential damage and to help ensure your own personal safety.

-  **CAUTION:** Before you begin any of the procedures in this section, follow the safety instructions in the *Product Information Guide*.
-  **CAUTION:** To reduce the risk of fire, electric shock, or injury, do not overload an electrical outlet, power strip, or convenience receptacle. The total ampere rating of all products plugged into an electrical outlet, power strip, or other receptacle should not exceed 80 percent of the branch circuit rating.
-  **CAUTION:** Your computer is heavy and can be difficult to maneuver. Seek assistance before attempting to lift, move, or tilt the computer and always lift correctly to avoid injury; avoid bending over while lifting.
-  **CAUTION:** The liquid cooling assembly is not user serviceable or upgradeable. All required service should be done by qualified service personnel only. The liquid cooling assembly in your system contains a non-refillable coolant. In the event of a coolant leak, shut down your system immediately. Unplug your system from the power outlet and contact Dell Technical Support. In the event of skin contact with the coolant, wash your skin with soap and water. Seek medical attention if irritation develops. In the event of eye contact with the coolant, rinse your eyes immediately with water, with your eyelids open, for 15 minutes. Seek medical attention if irritation persists.
-  **NOTICE:** Only a certified service technician should perform repairs on your computer. Damage due to servicing that is not authorized by Dell is not covered by your warranty.

- ➔ **NOTICE:** To avoid electrostatic discharge and damage to internal components, ground yourself by using a wrist grounding strap or by periodically touching an unpainted metal surface on the computer chassis.
 - ➔ **NOTICE:** Handle components and cards with care. Do not touch the components or contacts on a card. Instead, hold a card by its edges or by its metal mounting bracket. Hold a component such as a microprocessor by its edges, not by its pins.
 - ➔ **NOTICE:** When disconnecting a cable, pull on the cable's connector or its strain-relief loop, not on the cable itself. Some cables have connectors with locking tabs; before disconnecting this type of cable, press inward on the locking tabs to release the connector. When connecting or disconnecting a cable, ensure that the connectors are correctly oriented and aligned to avoid damage to the connector and/or the connector's pins.
- 1 Ensure that the work surface is level and protected to prevent either the surface or the computer from being scratched.
 - ➔ **NOTICE:** To avoid losing data, save any work in progress and exit all open programs before turning off your computer.
 - 2 Shut down the operating system:
 - In Windows XP, click **Start**→**Turn Off Computer**→**Turn off**.
 - In Windows Vista, click **Start** , click the arrow in the lower-right corner of the Start menu as shown below, and then click **Shut Down**.



The computer turns off after the operating system shutdown process is complete.

- 3 Ensure that the computer and all attached devices are turned off. If your computer and attached devices did not automatically turn off when you shut down your operating system, press and hold the power button for about 4 seconds to turn them off.
- ➔ **NOTICE:** When disconnecting a network cable, first unplug the cable from your computer and then unplug it from the network port or device.
- 4 Disconnect all external cables from the computer.
- 5 Carefully, lift the rear of the computer and rotate the stabilizing feet into the closed position.
- 6 With the help of an assistant, carefully lay the computer down on a flat surface with the computer cover facing up.

Removing the Computer Cover

 **CAUTION:** Before you begin any of the procedures in this section, follow the safety instructions in the *Product Information Guide*.

 **CAUTION:** To guard against electrical shock, always unplug your computer from the electrical outlet before removing the cover.

➡ **NOTICE:** To avoid electrostatic discharge and damage to internal components, ground yourself by using a wrist grounding strap or by periodically touching an unpainted metal surface on the computer chassis.

1 Follow the procedures in "Before You Begin" on page 85.

2 Pull back on the cover release latch.

➡ **NOTICE:** Ensure that sufficient space exists to support the removed cover—at least 30 centimeters (1 foot) of desktop space.

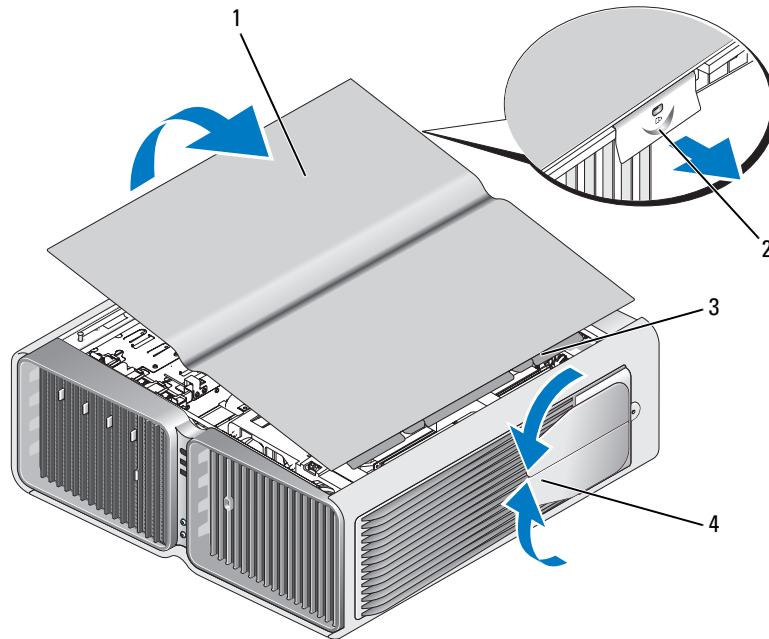

1 computer cover

2 cover release latch

3 cover hinge tabs

4 stabilizing feet (closed)

3 With the cover release latch pulled back, grip the sides of the cover, then pivot the top of the cover up and away from the computer.

4 Slide the cover forward and up to remove it from the hinge slots, then set it aside in a secure and protected location.

Inside View of Your Computer

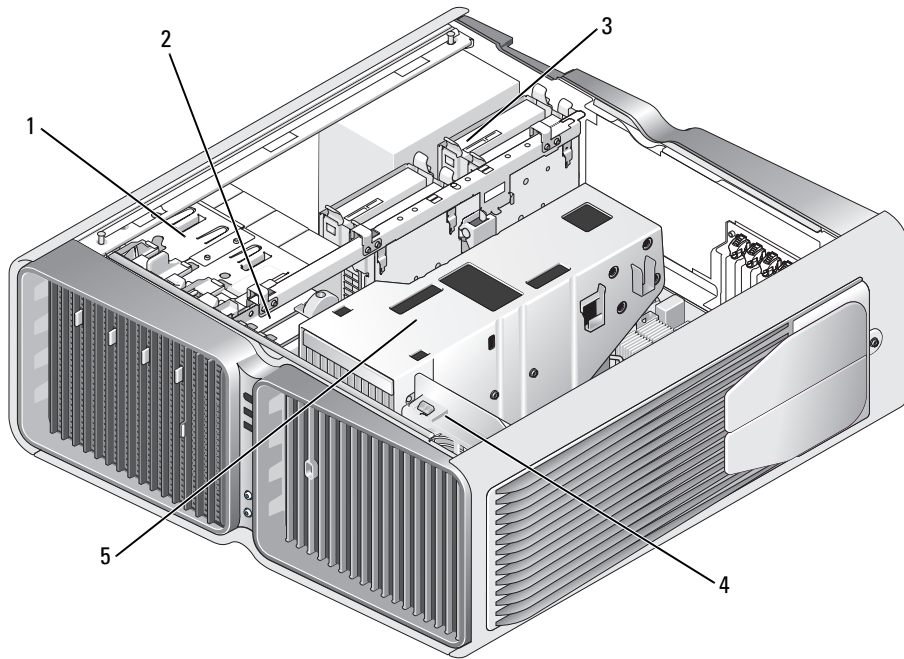

1 optical drive bays (4)

2 floppy drive/media card reader

3 hard drive bays (4)

4 card fan

5 liquid cooling assembly

System Board Components

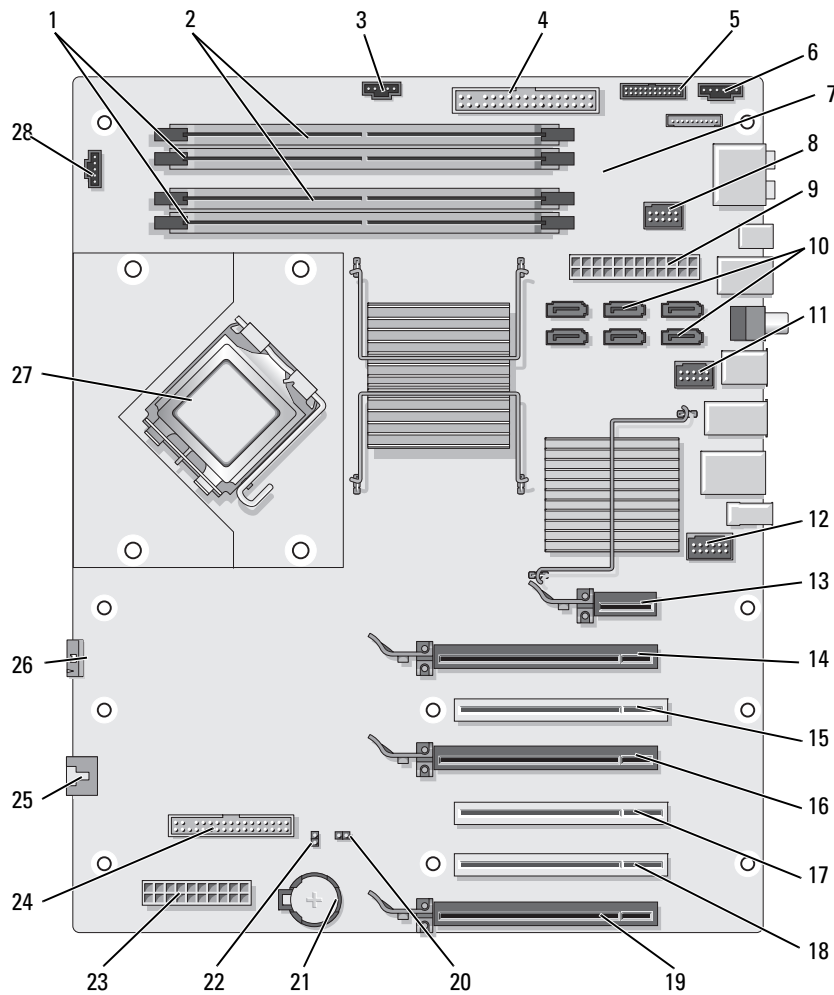

- | | | | | | |
|----|--|----|--|----|-------------------------------------|
| 1 | <i>white</i> memory module connectors (DIMM_1-2) | 2 | <i>black</i> memory module connectors (DIMM_3-4) | 3 | hard drive fan connector (FAN_HDD) |
| 4 | IDE drive connector (IDE) | 5 | front I/O panel connector (FRONTPANEL) | 6 | back LED connector |
| 7 | power button (PWR_BT) | 8 | FlexBay connector (INT_USB) | 9 | main power connector (POWER1) |
| 10 | SATA connectors (SATA0-5) | 11 | front USB connector (FRNT_USB) | 12 | front panel 1394 connector (FP1394) |

13	PCI-Express x1 card slot (SLOT1) This slot is not available in the dual-graphics configuration	14	PCI-Express x16 card slot (SLOT2)	15	PCI card slot (SLOT3) This slot is not available in the dual-graphics or double-width, single graphics configuration.
16	PCI-Express x16 card slot (SLOT4)	17	PCI card slot (SLOT5)	18	PCI card slot (SLOT6)
19	PCI-Express x16 card slot (SLOT7)	20	RTC reset jumper (RTC_RST)	21	battery socket (BATTERY)
22	password jumper (PASSWORD)	23	power connector (POWER2)	24	floppy drive (DSKT)
25	card cage fan connector (FAN_CAGE)	26	liquid cooling assembly (TEC_PUMP)	27	processor (CPU)
28	processor fan connector (FAN1_CPU)				

Memory

You can increase your computer memory by installing memory modules on the system board.

Your computer supports DDR2 memory. For additional information on the type of memory supported by your computer, see "Memory" on page 163.

DDR2 Memory Overview

- DDR2 memory modules should be installed in *pairs of matched memory size and speed*. If the DDR2 memory modules are not installed in matched pairs, the computer will continue to operate, but with a slight reduction in performance. See the label on the upper-right or upper-left corner of the module to determine the module's capacity.



NOTE: Always install DDR2 memory modules in the order indicated on the system board.

The recommended memory configurations are:

- A pair of matched memory modules installed in DIMM connectors 1 and 2

or

- A pair of matched memory modules installed in DIMM connectors 1 and 2 and another matched pair installed in DIMM connectors 3 and 4

NOTICE: Do not install ECC memory modules.

- If you install mixed pairs of PC2-5300 (DDR2 667-MHz) and PC2-6400 (DDR2 800-MHz) memory, the modules function at the speed of the slowest module installed.
- Be sure to install a single memory module in DIMM connector 1, the connector closest to the processor, before you install modules in any other connector.

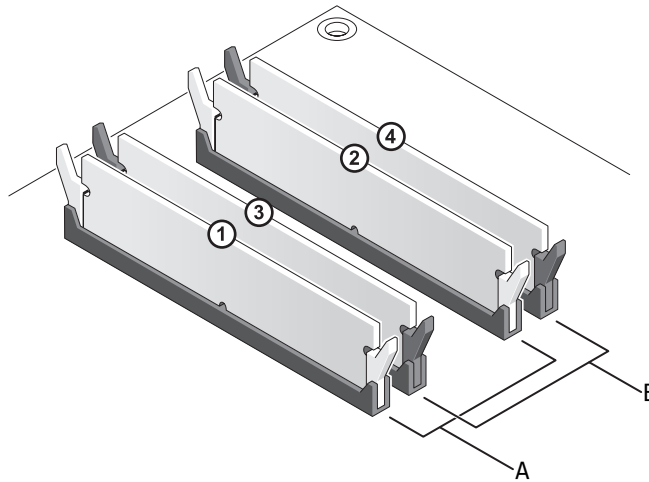

A matched pair of modules in DIMM connectors 1 and 2 (white securing clips)

B matched pair of memory modules in DIMM connectors 3 and 4 (black securing clips)

NOTICE: If you remove your original memory modules from the computer during a memory upgrade, keep them separate from any new modules that you may have, even if you purchased the new modules from Dell. If possible, do not pair an original memory module with a new memory module. Otherwise, your computer may not start properly. You should install your original memory modules in pairs either in DIMM connectors 1 and 2 or DIMM connectors 3 and 4.

NOTE: Memory purchased from Dell is covered under your computer warranty.

Addressing Memory Configurations

If you are using a 32-bit operating system such as Microsoft® Windows Vista™, your computer will support a maximum of 4 GB of memory. If you are using a 64-bit operating system, your computer will support a maximum of 8 GB (2-GB DIMMs in each of the four slots) of memory.

Installing Memory

⚠ CAUTION: Before you begin any of the procedures in this section, follow the safety instructions in the *Product Information Guide*.

➡ NOTICE: To avoid electrostatic discharge and damage to internal components, ground yourself by using a wrist grounding strap or by periodically touching an unpainted metal surface on the computer chassis.

- 1 Follow the procedures in "Before You Begin" on page 85.
- 2 Remove the computer cover (see "Removing the Computer Cover" on page 86).
- 3 Press out the securing clip at each end of the memory module connector.

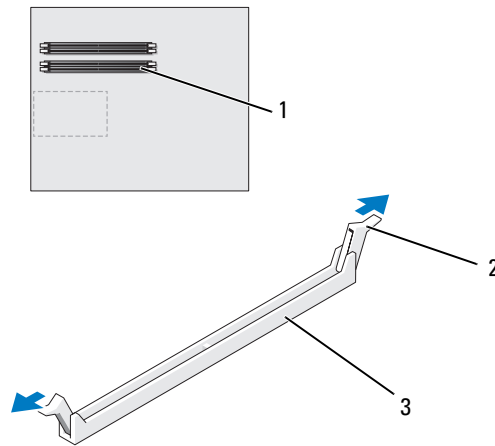

- 1 memory connector closest to processor 2 securing clips (2) 3 memory connector

- 4 Align the notch on the bottom of the module with the crossbar in the connector.

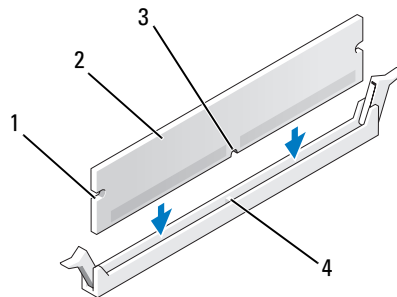

- 1 cutouts (2) 2 memory module 3 notch
4 crossbar

- ➔ **NOTICE:** To avoid damage to the memory module, press the module straight down into the connector while you apply equal force to each end of the module.
- 5 Insert the module into the connector until the module snaps into position.
If you insert the module correctly, the securing clips snap into the cutouts at each end of the module.

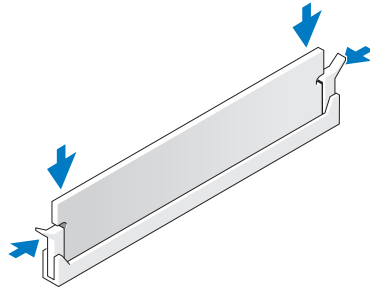

- 6 Replace the computer cover (see "Replacing the Computer Cover" on page 160).
- ➔ **NOTICE:** To connect a network cable, first plug the cable into the network port or device and then plug it into the computer.
- 7 Connect your computer and devices to electrical outlets, and turn them on.
- 8 When the message appears stating that memory size has changed, press <F1> to continue.
- 9 Log on to your computer.
- 10 Right-click the **My Computer** icon on your Windows desktop and click **Properties**.
- 11 Click the **General** tab.
- 12 To verify that the memory is installed correctly, check the amount of memory (RAM) listed.

Removing Memory

⚠ **CAUTION:** Before you begin any of the procedures in this section, follow the safety instructions in the *Product Information Guide*.

➔ **NOTICE:** To avoid electrostatic discharge and damage to internal components, ground yourself by using a wrist grounding strap or by periodically touching an unpainted metal surface on the computer chassis.

- 1 Follow the procedures in "Before You Begin" on page 85.
- 2 Press out the securing clip at each end of the memory module connector.
- 3 Grasp the module and pull up.

If the module is difficult to remove, gently ease the module back and forth to remove it from the connector.

Cards

CAUTION: Before you begin any of the procedures in this section, follow the safety instructions in the *Product Information Guide*.

Your computer provides the following slots for PCI and PCI Express cards:

- Three PCI card slots
- Two PCI Express x16 card slots (can be used in a dual-graphics configuration)
- One PCI Express x16 card slot (wired as x8)
- One PCI Express x1 card slot

NOTE: If a graphics card is installed in each of the PCI Express x16 card slots in the dual-graphics configuration, the PCI Express x1 and one PCI card slot are not accessible for use.

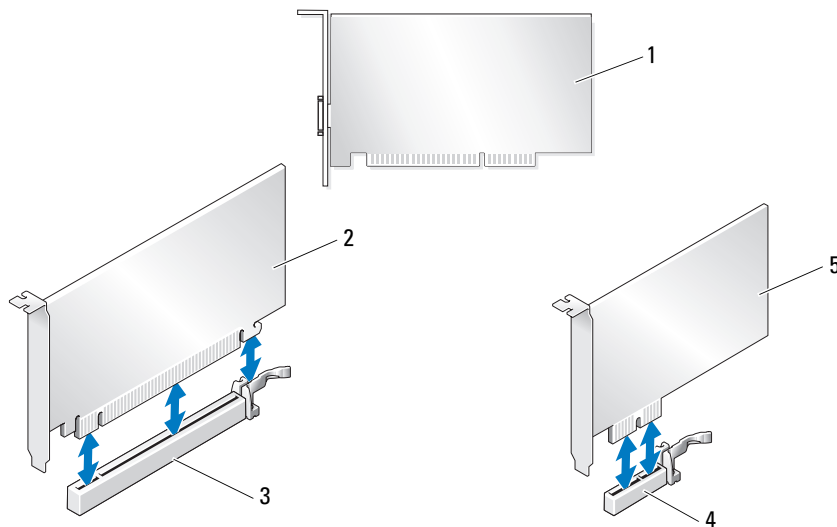

1 PCI card

2 PCI Express x16 card

3 PCI Express x16 card slot

4 PCI Express x1 card slot

5 PCI Express x1 card

Removing PCI and PCI Express Cards

- ➔ **NOTICE:** To avoid electrostatic discharge and damage to internal components, ground yourself by using a wrist grounding strap or by periodically touching an unpainted metal surface on the computer chassis.
 - ➔ **NOTICE:** If your computer came with a PCI graphics card installed, removal of the card is not necessary when installing additional graphics cards; however, the card is required for troubleshooting purposes. If you remove the card, store it in a safe and secure location.
 - ➔ **NOTICE:** If you have the optional dual graphics card configuration, see "Removing a PCI Express Graphics Card from a Dual Configuration" on page 100 to remove or replace a graphics card.
- 1 Follow the procedures in "Before You Begin" on page 85.
 - 2 Remove the computer cover (see "Removing the Computer Cover" on page 86).
 - 3 Disconnect any cables connected to the card.
 - 4 Press down the tab on the top of the card retainer at the appropriate card slot and pivot the card retainer back through the chassis wall.
 - 5 If present, press the tab on the card retention device that lays over the installed cards and lift it to gain full access to the card.

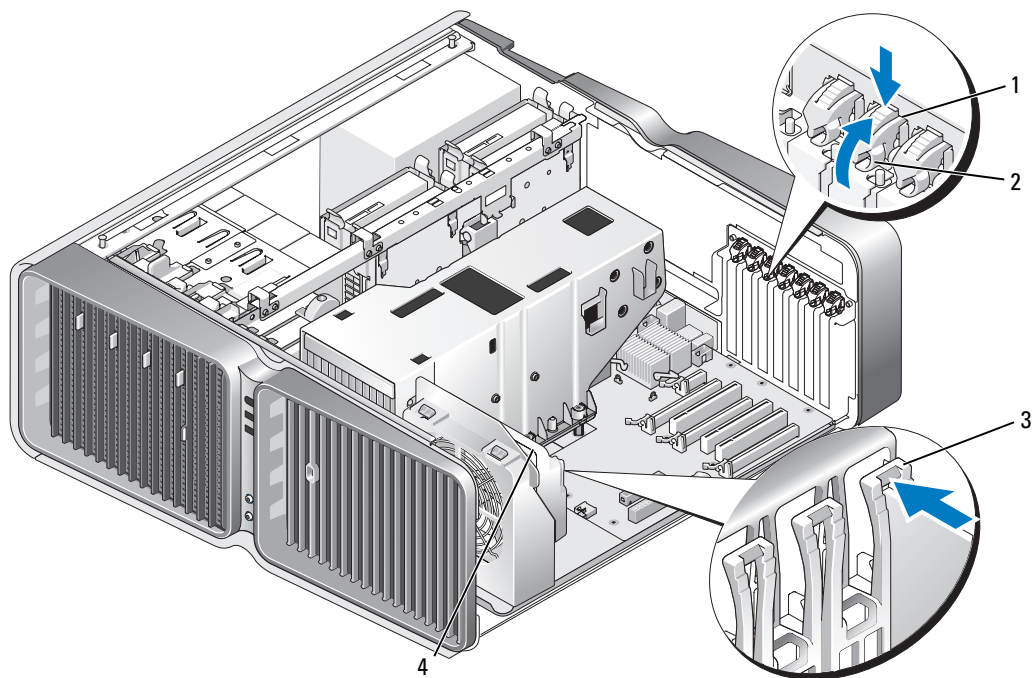

1 release tab

2 card retainer

3 alignment guide

4 fan bracket

- 6 Press the release tab (if present) on the system board connector as you grasp the card by its top corners, and then ease the card out of the connector.

 **NOTE:** If the card is full length, press the release tab on the end of the alignment guides on the fan bracket.

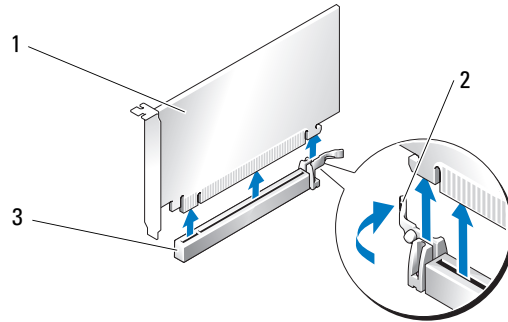

- 1 PCI Express x16 card 2 securing tab 3 PCI Express x16 card slot

- 7 Install a filler bracket in the empty card-slot opening. If you are replacing the card, see "Installing PCI and PCI Express Cards" on page 97.

 **NOTE:** Installing filler brackets over empty card-slot openings is necessary to maintain FCC certification of the computer. The brackets also keep dust and dirt out of your computer.

 **NOTICE:** Before rotating the card retainer back into place, ensure that the tops of all cards and filler brackets are flush with the alignment bar and the notch in the top of each card or filler bracket fits around the alignment guide.

 **NOTICE:** Do not route card cables over or behind the cards. Cables routed over the cards can prevent the computer cover from closing properly or cause damage to the equipment.

- 8 Rotate the card retainer back into its original position; push its tip so that its tab clicks into place.

 **NOTICE:** To connect a network cable, first plug the cable into the network port or device and then plug the cable into the computer.

- 9 If present, lower the card retention device that lays over the installed cards and snap it into place.

- 10 Replace the computer cover (see "Replacing the Computer Cover" on page 160), reconnect the computer and devices to electrical outlets, and then turn them on.

- 11 Uninstall the driver for the card that you removed.

 **NOTE:** If you removed a sound card or a network adapter, see "Network Adapter and Sound Card Settings" on page 105.

Installing PCI and PCI Express Cards

- ➔ **NOTICE:** To avoid electrostatic discharge and damage to internal components, ground yourself by using a wrist grounding strap or by periodically touching an unpainted metal surface on the computer chassis.
 - ➔ **NOTICE:** If your computer came with a PCI graphics card installed, removal of the card is not necessary when installing additional graphics cards; however, the card is required for troubleshooting purposes. If you remove the card, store it in a safe and secure location.
 - ➔ **NOTICE:** If you have or are upgrading to the optional dual-graphics configuration, see "Installing a PCI Express Graphics Card in a Dual Configuration" on page 102 to install a graphics card.
- 1 Follow the procedures in "Before You Begin" on page 85.
 - 2 Remove the computer cover (see "Removing the Computer Cover" on page 86).
 - 3 If present, press the tab on the card retention device that lays over the installed cards and rotate it upwards to gain full access to the card.
 - 4 Press down the tab on the top of the card retainer at the appropriate card slot and pivot the card retainer back through the chassis wall.

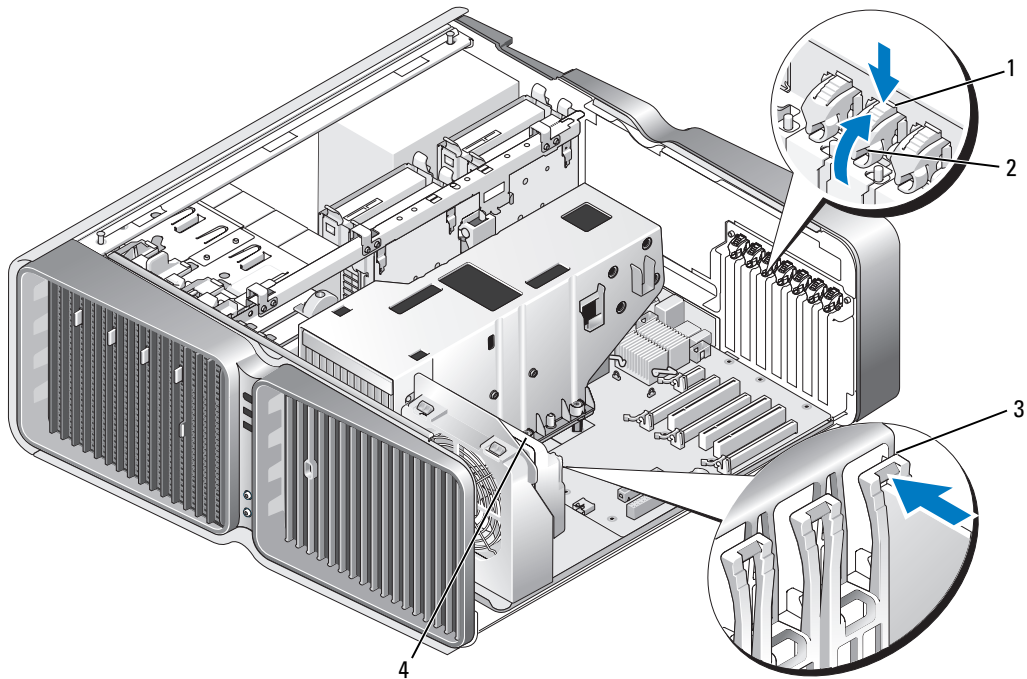

1 release tab
4 fan bracket

2 card retainer

3 alignment guide

- 5 Remove the filler bracket or existing card (see "Removing PCI and PCI Express Cards" on page 95) to create a card-slot opening.
- 6 Prepare the card for installation.
See the documentation that came with the card for information on configuring the card, making internal connections, or otherwise customizing it for your computer.
- 7 Position the card so that it is aligned with the slot and the securing tab (if present) is aligned with the securing slot.

 **NOTE:** If the card is full length, insert the card guide into the alignment slot on the fan bracket.

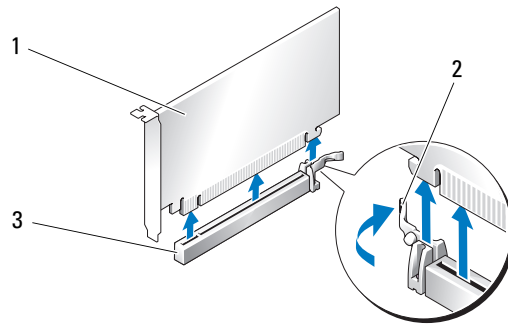

1 PCI Express x16 card

2 securing tab

3 PCI Express x16 card slot

 **NOTICE:** Ensure that you release the securing tab to seat the card. If the card is not installed correctly, you may damage the system board.

- 8 Gently pull the securing tab (if present) and place the card in the connector. Press down firmly and ensure that the card is fully seated in the slot.

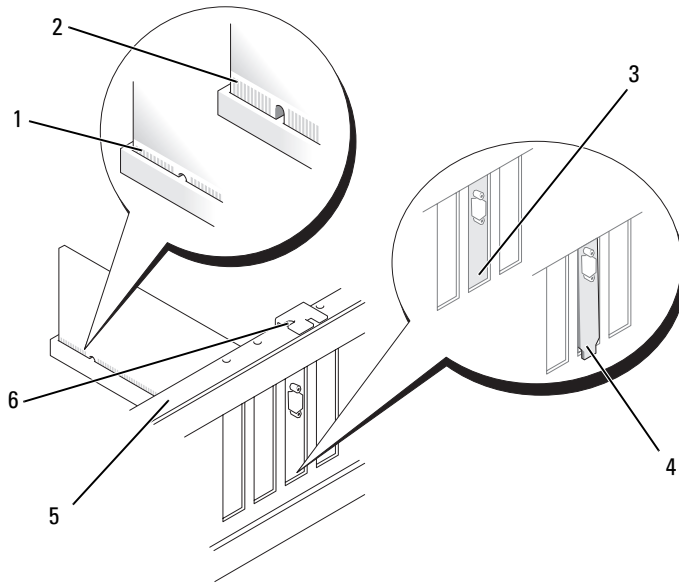

- | | | | | | |
|---|--|---|-----------------------------|---|--------------------------------------|
| 1 | card connector (seated) | 2 | card connector (not seated) | 3 | bracket properly aligned within slot |
| 4 | bracket improperly aligned outside of slot | 5 | alignment bar | 6 | alignment guide |

➔ **NOTICE:** Do not route card cables over or behind the cards. Cables routed over the cards can prevent the computer cover from closing properly or cause damage to the equipment.

➔ **NOTICE:** An incorrectly attached graphics power cable may result in degraded graphics performance.

9 Connect any cables that should be attached to the card.

See the documentation for the card for information about the card's cable connections.

➔ **NOTICE:** Before rotating the card retainer back into place, ensure that the tops of all cards and filler brackets are flush with the alignment bar and the notch in the top of each card or filler bracket fits around the alignment guide.

10 Rotate the card retainer back into its original position; push its tip so that its tab clicks into place.

11 If present, lower the card retention device that lays over the installed cards and snap it into place.

➔ **NOTICE:** To connect a network cable, first plug the cable into the network port or device and then plug the cable into the computer.

12 Replace the computer cover (see "Replacing the Computer Cover" on page 160), reconnect the computer and devices to electrical outlets, and then turn them on.

- 13 Install any drivers required for the card as described in the card documentation.

 **NOTE:** If you installed a sound card or a network adapter, see "Network Adapter and Sound Card Settings" on page 105.

Removing a PCI Express Graphics Card from a Dual Configuration

 **NOTE:** This section regards dual configurations of PCI Express x16 graphics cards only. For removal of any other type of PCI or PCI Express cards, see "Removing PCI and PCI Express Cards" on page 95.

- 1 Follow the procedures in "Before You Begin" on page 85.
- 2 Remove the computer cover (see "Removing the Computer Cover" on page 86).
- 3 If present, press the tab on the card retention device that lays over the installed cards and rotate it upwards to gain full access to the card.
- 4 Gently securing both graphics cards with one hand, remove the graphics card bridge (if present) with your other hand by pulling it up and away from the computer. Set it aside.

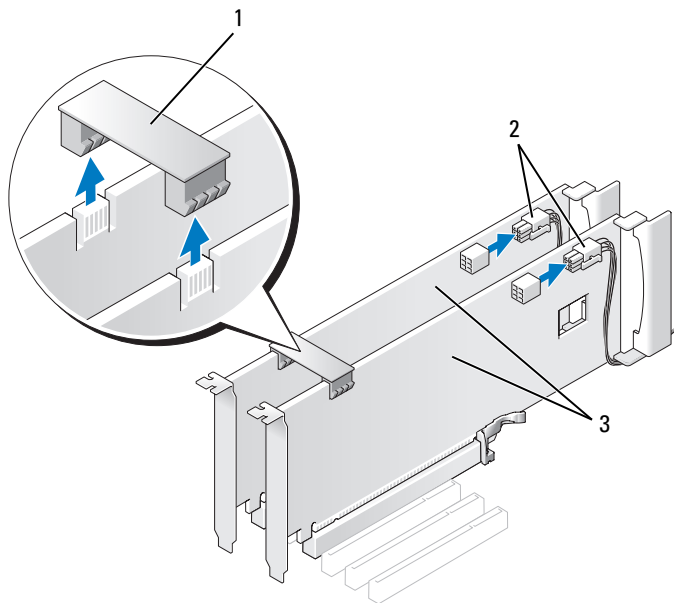

1 graphics card bridge

2 power connectors (2)

3 dual-PCI Express graphics cards

- 5 Disconnect any cables connected to the card.
- 6 Press down the tab on the top of the card retainer at the appropriate card slot and pivot the card retainer back through the chassis wall.

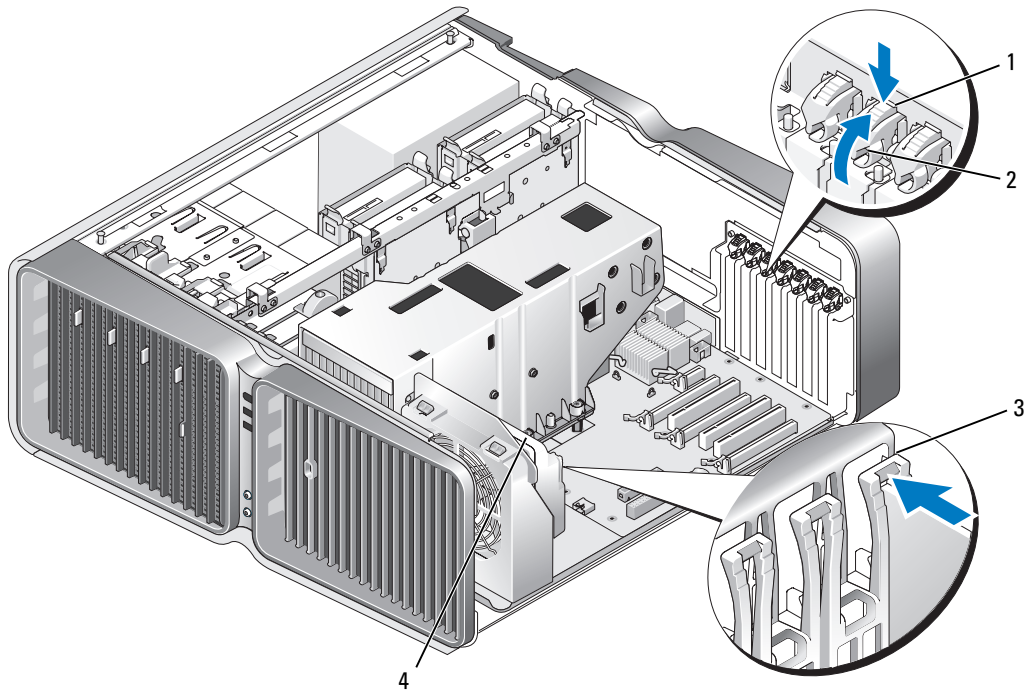

1 release tab
4 fan bracket

2 card retainer

3 alignment guide

- 7 Press the release tab (if present) on the system board connector as you grasp the card by its top corners, and then ease the card out of the connector.



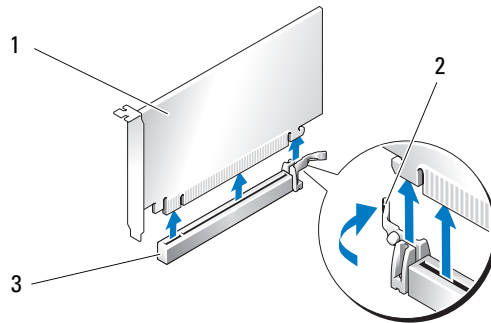

NOTE: If the card is full length, press the release tab on the end of the alignment guides on the fan bracket.





1 PCI Express x16 card 2 securing tab 3 PCI Express x16 card slot

- 8 Install a filler bracket in the empty card-slot opening. If you are replacing the card, see "Installing a PCI Express Graphics Card in a Dual Configuration" on page 102.

 **NOTE:** Installing filler brackets over empty card-slot openings is necessary to maintain FCC certification of the computer. The brackets also keep dust and dirt out of your computer.

 **NOTE:** The graphics card bridge (not present in all dual-graphics configurations) is not necessary in a single graphics card configuration.

 **NOTICE:** Before rotating the card retainer back into place, ensure that the tops of all cards and filler brackets are flush with the alignment bar and the notch in the top of each card or filler bracket fits around the alignment guide.

 **NOTICE:** Do not route card cables over or behind the cards. Cables routed over the cards can prevent the computer cover from closing properly or cause damage to the equipment.

- 9 Rotate the card retainer back into its original position; push its tip so that its tab clicks into place.

 **NOTICE:** To connect a network cable, first plug the cable into the network port or device and then plug the cable into the computer.

- 10 If present, lower the card retention device that lays over the installed cards and snap it into place.

- 11 Replace the computer cover (see "Replacing the Computer Cover" on page 160), reconnect the computer and devices to electrical outlets, and then turn them on.

Installing a PCI Express Graphics Card in a Dual Configuration

 **NOTE:** To upgrade to or downgrade from a dual-graphics configuration, you will need additional parts that can be ordered from Dell (see "Contacting Dell" on page 181).

This section pertains to dual PCI Express graphics card configurations only. For installation of other types of PCI or PCI Express cards, see "Installing PCI and PCI Express Cards" on page 97.

The PCI Express x1 card slot is not available for use if a graphics card is installed in each of the PCI Express x16 card slots in a dual graphics card configuration. If you are upgrading from a single graphics card to a dual-graphics card configuration, you will need to remove any card installed in the PCI Express x1 card slot (see "System Board Components" on page 89 to locate the PCI Express x1 card slot). To remove a PCI Express card, see "Removing PCI and PCI Express Cards" on page 95.

➔ NOTICE: For information about upgrading your system to use NVIDIA SLI (Scalable Link Interface) dual-graphics technology, see the Dell website at support.dell.com.

To learn more about NVIDIA SLI (Scalable Link Interface) dual graphics technology, see "Understanding Dual-Graphics Technology" on page 49.

- 1 Follow the procedures in "Before You Begin" on page 85.
- 2 Remove the computer cover (see "Removing the Computer Cover" on page 86).
- 3 If present, press the tab on the card retention device that lays over the installed cards and rotate it upwards to gain full access to the card.
- 4 Press down the tab on the top of the card retainer at the appropriate card slot and pivot the card retainer back through the chassis wall.

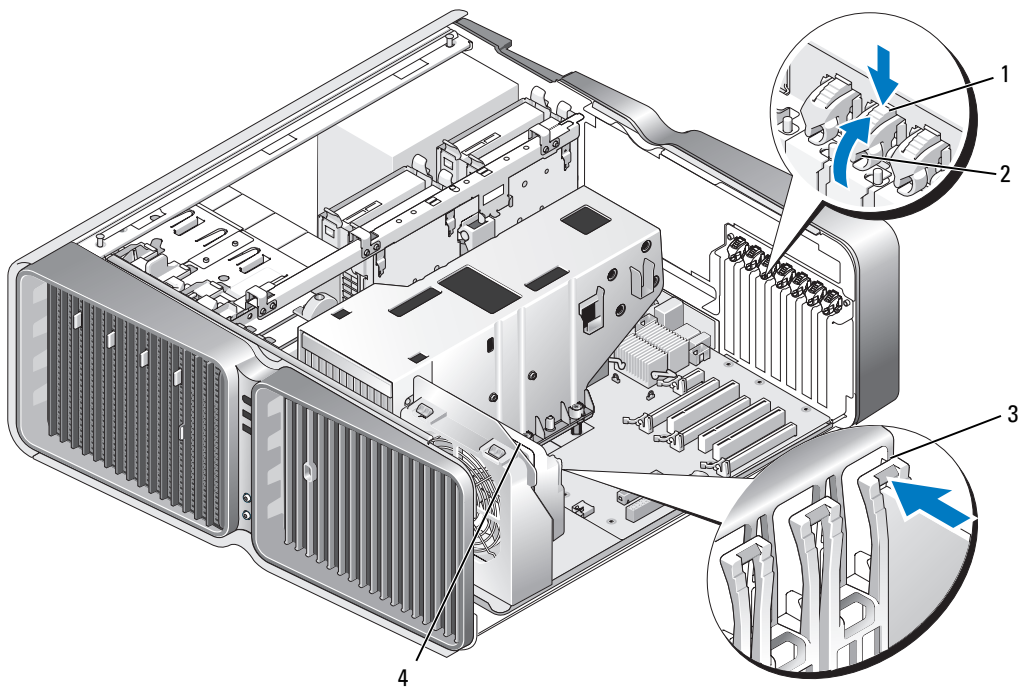

1 release tab
4 fan bracket

2 card retainer

3 alignment guide

- 5 Remove the filler bracket or existing graphics card (see "Removing a PCI Express Graphics Card from a Dual Configuration" on page 100) to create a card-slot opening.

 **NOTE:** If you are upgrading to a dual graphics card configuration and have a card installed in the PCI Express x1 card slot, remove the card (see "Removing PCI and PCI Express Cards" on page 95).

- 6 Prepare the card for installation.

See the documentation that came with the card for information on configuring the card, making internal connections, or otherwise customizing it for your computer.

- 7 Position the card so that it is aligned with the slot and the securing tab (if present) is aligned with the securing slot.

 **NOTE:** If the card is full length, insert the card guide into the alignment slot on the fan bracket.

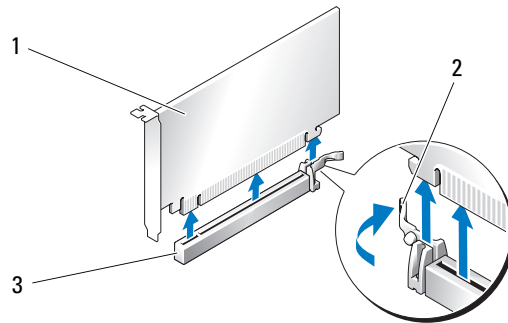

1 PCI Express x16 card

2 securing tab

3 PCI Express x16 card slot

 **NOTICE:** Ensure that you release the securing tab to seat the card. If the card is not installed correctly, you may damage the system board.

- 8 Gently pull the securing tab (if present) and place the card in the connector. Press down firmly and ensure that the card is fully seated in the slot.

 **NOTICE:** Do not route card cables over or behind the cards. Cables routed over the cards can prevent the computer cover from closing properly or cause damage to the equipment.

 **NOTICE:** An incorrectly attached graphics power cable may result in degraded graphics performance.

- 9 Connect any cables that should be attached to the card.

See the documentation for the card for information about the card's cable connections.

 **NOTICE:** Before rotating the card retainer back into place, ensure that the tops of all cards and filler brackets are flush with the alignment bar and the notch in the top of each card or filler bracket fits around the alignment guide.

- 10 Rotate the card retainer back into its original position; push its tip so that its tab clicks into place.

- 11 Attach the graphics card bridge (if required for your dual-graphics configuration), pressing firmly so that it completely covers the connector tabs.

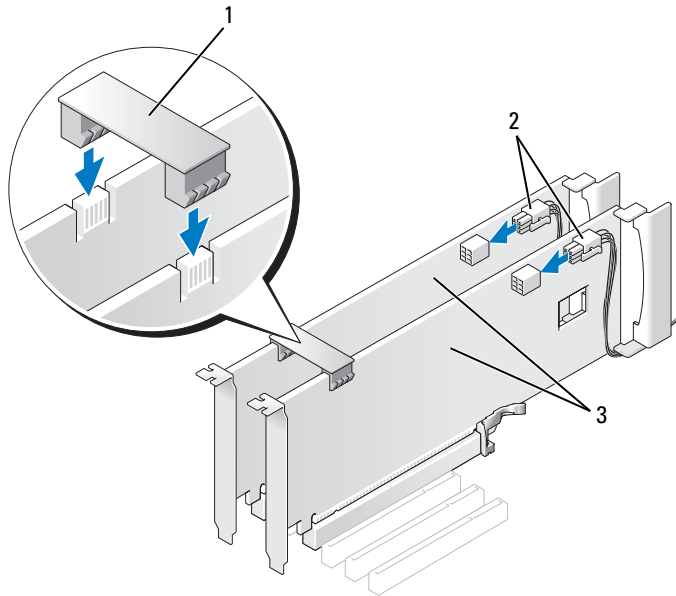

- | | | |
|--|------------------------|-----------------------------------|
| 1 graphics card bridge (not present on some dual graphics card configurations) | 2 power connectors (2) | 3 dual-PCI Express graphics cards |
|--|------------------------|-----------------------------------|

➔ NOTICE: To connect a network cable, first plug the cable into the network port or device and then plug the cable into the computer.

- 12** If present, lower the card retention device that lays over the installed cards and snap it into place.
- 13** Replace the computer cover (see "Replacing the Computer Cover" on page 160), reconnect the computer and devices to electrical outlets, and then turn them on.

Network Adapter and Sound Card Settings

If you installed a sound card:

- 1** Enter system setup (see "Entering System Setup" on page 168), select **Integrated Audio Controller**, and then change the setting to **Off**.
- 2** Connect external audio devices to the sound card connectors. Do not connect external audio devices to the microphone, speaker/headphone, or line-in connectors on the back panel.

If you removed a sound card:

- 1** Enter system setup (see "Entering System Setup" on page 168), select **Integrated Audio Controller**, and then change the setting to **On**.
- 2** Connect external audio devices to the audio connectors on the back panel of the computer.

If you installed an add-in network adapter and want to disable the integrated network adapter:

- 1 Enter system setup (see "Entering System Setup" on page 168), select **Integrated NIC Controller**, and then change the setting to **Off**.
- 2 Connect the network cable to the add-in network adapter connectors. Do not connect the network cable to the integrated connector on the back panel.

If you removed an add-in network connector:

- 1 Enter system setup (see "Entering System Setup" on page 168), select **Integrated NIC Controller**, and then change the setting to **On**.
- 2 Connect the network cable to the integrated connector on the back panel of the computer.

Drives

Your computer supports:

- Six SATA devices (hard drives or optical drives)
- Two IDE devices (two hard drives or two optical drives)
- One floppy drive
- One Media Card Reader



NOTICE: When removing and replacing drives, be sure to leave the drive data and power cables connected to the system board.



NOTE: The 5.25-inch Media Card Reader/floppy drive carrier is not interchangeable with the hard drive carrier.

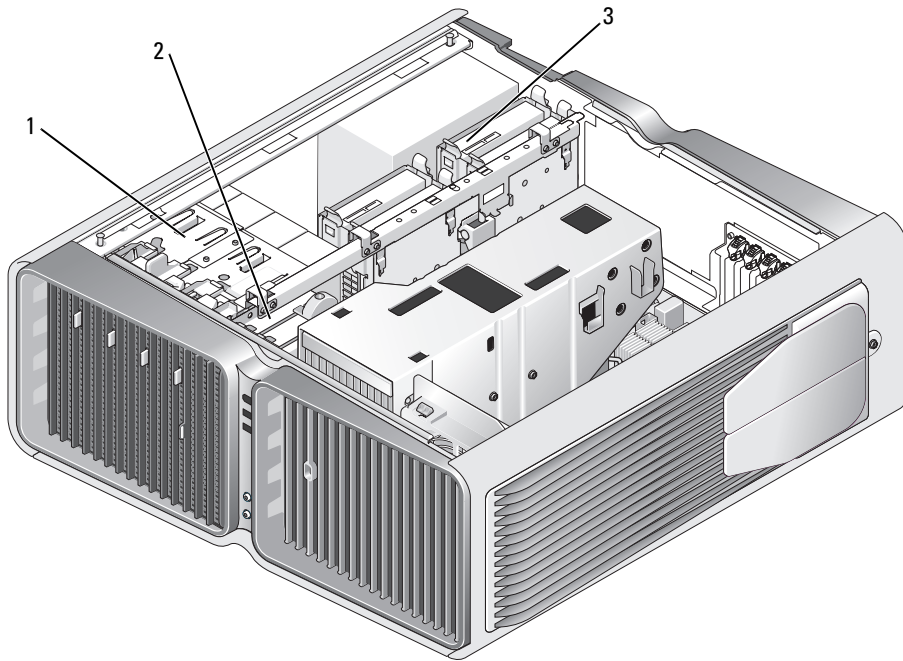

1 optical drive bays (4)

2 floppy drive/media card reader

3 hard-drive bays (4)

About Serial ATA Drives

Your computer supports up to four serial ATA hard drives and two serial ATA optical drives. Serial ATA drives provide the following benefits by transferring data using serial technology and flexible cables that are thinner and longer than IDE cables:

- Improved cable routing facilitates more efficient airflow inside the chassis.
- Compact cable connectors save space on the system board and on the hard drive, allowing for more efficient utilization of space inside the chassis.

General Drive Installation Guidelines

SATA hard drives should be connected to connectors labeled "HDD" on the system board. Non-hard drive SATA devices should be attached to the connectors labeled SATA, with the exception of a 5th SATA hard drive installed in a 5.25-inch drive bay, which must be connected to the SATA0 connector. IDE optical drives should be connected to the connectors labeled "IDE."

When connecting a SATA cable, hold the cable by the connector at each end and press firmly into the connector. When disconnecting a SATA cable, hold the cable by the connector at each end and pull until the connector detaches.

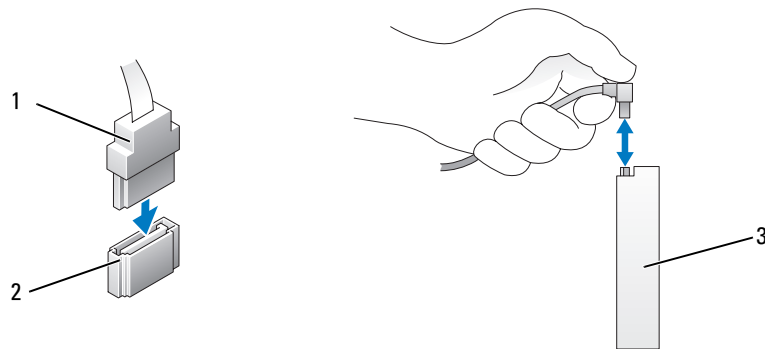

1 SATA data cable

2 SATA data connector (on the system board)

3 SATA drive

When you connect two IDE devices to a single IDE data cable and configure the devices for the cable select setting, the device attached to the last connector on the data cable is primary or the boot device, and the device attached to the middle connector on the data cable is the secondary device. See the drive documentation in your upgrade kit for information on configuring devices for the cable select setting.

To connect an IDE data cable, align the tab on one connector with the notch on the other. When disconnecting an IDE data cable, grasp the colored pull-tab and pull until the connector detaches.

Hard Drive

Removing a Hard Drive



CAUTION: Before you begin any of the procedures in this section, follow the safety instructions in the *Product Information Guide*.



CAUTION: To guard against electrical shock, always unplug your computer from the electrical outlet before removing the cover.



NOTICE: If you are replacing a hard drive that contains data that you want to keep, back up your files before you begin this procedure.

- 1 Follow the procedures in "Before You Begin" on page 85.
- 2 Remove the computer cover (see "Removing the Computer Cover" on page 86).
- 3 Disconnect the power cable and the data cable from the hard drive.

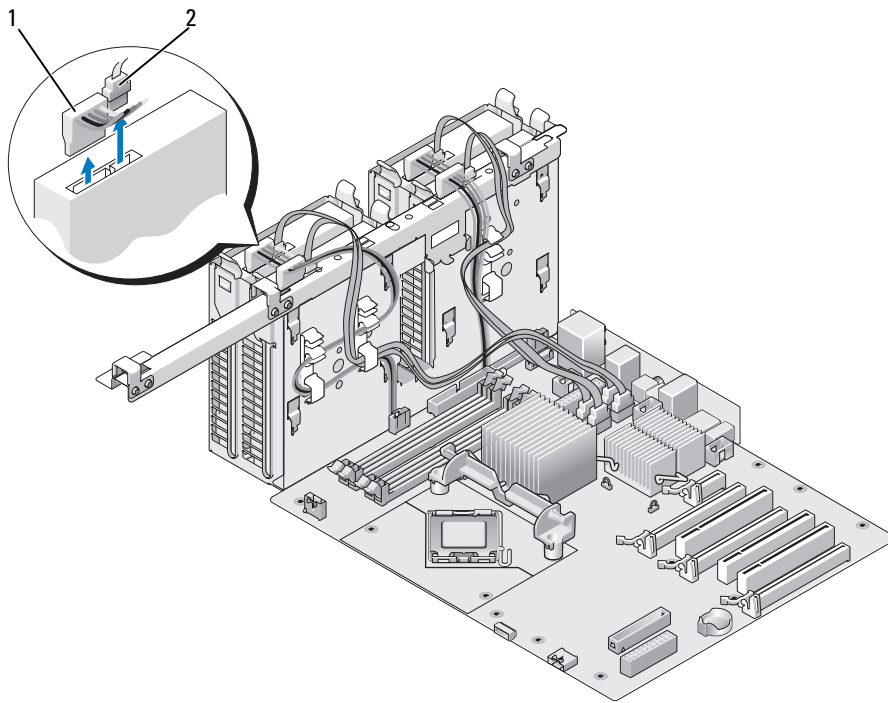

1 power cable

2 data cable

- 4 Press the blue tabs on each side of the hard drive bracket toward each other and slide the drive up and out of the hard-drive bay.

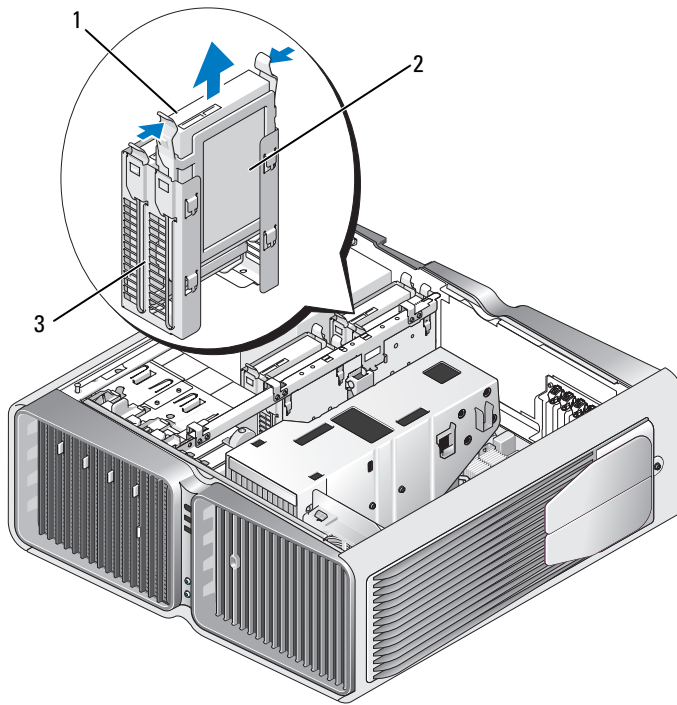

- 1 blue tabs (2) 2 hard drive 3 hard drive bay

- 5 Ensure that all connectors are properly cabled and firmly seated.
- 6 Replace the computer cover (see "Replacing the Computer Cover" on page 160).
- ➔ **NOTICE:** To connect a network cable, first plug the cable into the network port or device and then plug it into the computer.
- 7 Connect the computer and devices to electrical outlets, and turn them on.

Installing a Hard Drive

⚠ CAUTION: Before you begin any of the procedures in this section, follow the safety instructions in the *Product Information Guide*.

- 1 Follow the procedures in "Before You Begin" on page 85.
- 2 Remove the computer cover (see "Removing the Computer Cover" on page 86).
- 3 Remove the existing hard drive, if applicable (see "Removing a Hard Drive" on page 108).

✍ NOTE: If a hard drive bracket is installed inside of the hard drive bay, remove the bracket before you install the new hard drive.

- 4 Prepare the new hard drive for installation and check the documentation for the hard drive to verify that the drive is configured for your computer.

 **NOTE:** If hard drive you are installing does not have the hard drive bracket attached, use your original hard drive bracket; snap the bracket onto the new drive.

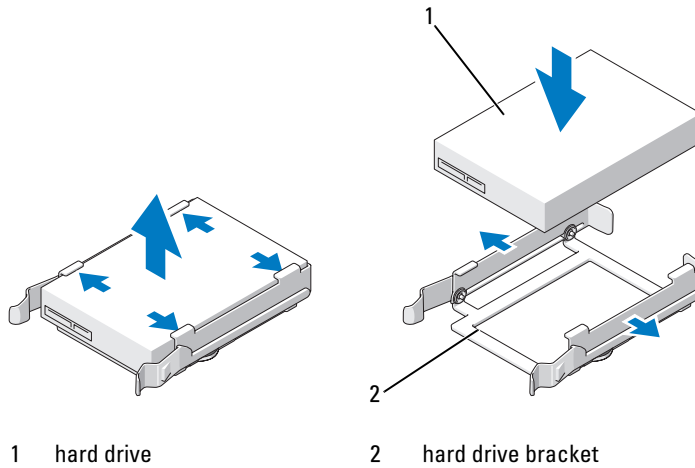

- 5 Verify that the hard drive bay is empty and unobstructed.
- 6 Slide the hard drive into the hard drive bay until it clicks securely into place.

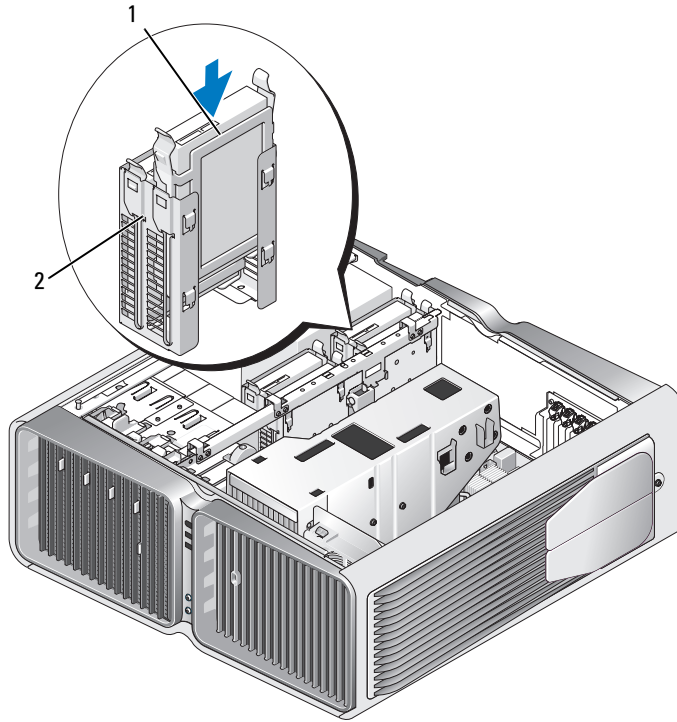

1 hard drive

2 hard drive bay

➔ **NOTICE:** Ensure that all connectors are properly cabled and firmly seated.

- 7 Connect the power cable to the hard drive.
- 8 Connect the hard drive data cable to the hard drive.

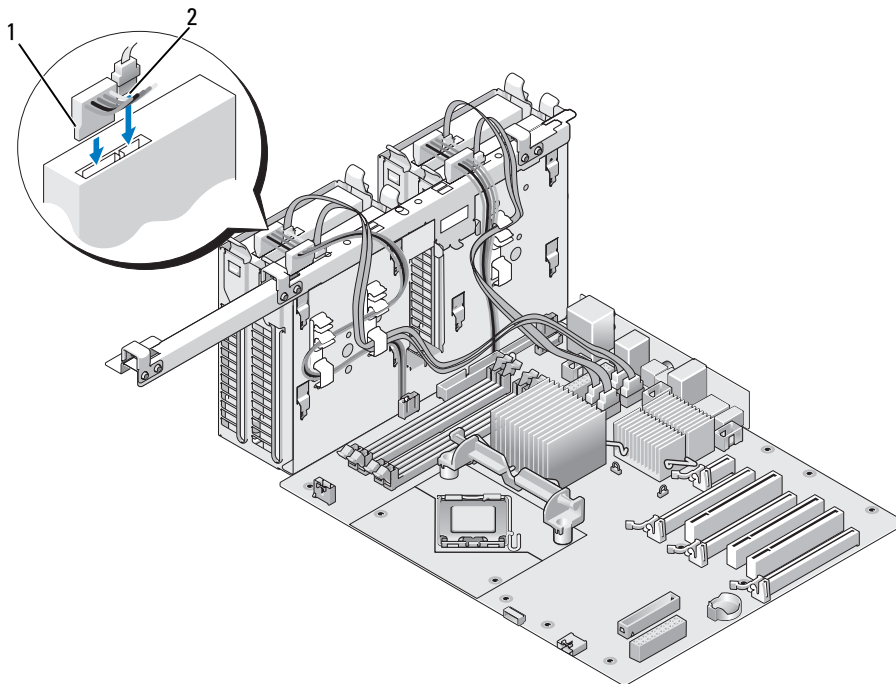

1 power cable

2 data cable

9 Replace the computer cover (see "Replacing the Computer Cover" on page 160).

NOTICE: To connect a network cable, first plug the cable into the network port or device and then plug it into the computer.

10 Connect the computer and devices to electrical outlets, and turn them on.

See the documentation that came with the drive for instructions on installing any software required for drive operation.

Drive Panel

CAUTION: Before you begin any of the procedures in this section, follow the safety instructions in the *Product Information Guide*.

Removing the Drive Panel

1 Follow the procedures in "Before You Begin" on page 85.

2 Remove the computer cover (see "Removing the Computer Cover" on page 86).

- 3 Grasp the drive release latch and slide it towards the base of the computer until the drive panel snaps open.

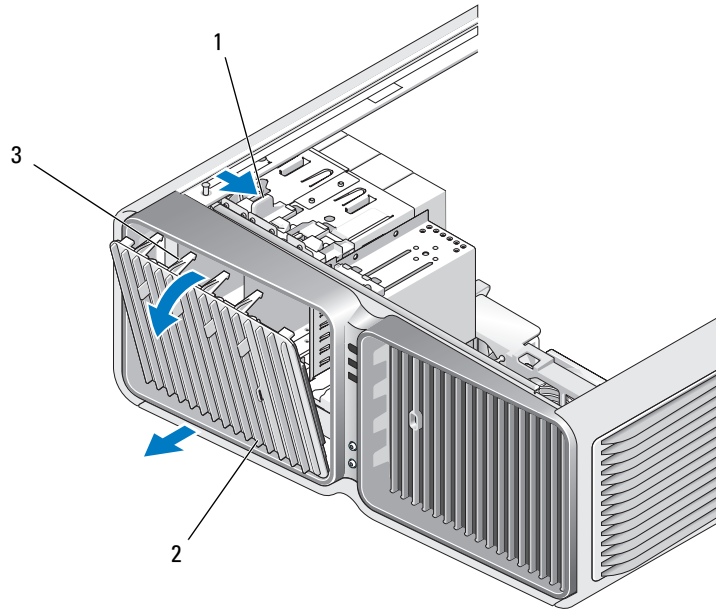

1 drive release latch

2 drive panel

3 drive panel tabs

- 4 Pivot the drive panel outward and lift it from its side hinges.
- 5 Set the drive panel aside in a secure location.

Replacing the Drive Panel

- 1 Follow the procedures in "Before You Begin" on page 85.
- 2 Remove the computer cover (see "Removing the Computer Cover" on page 86).
- 3 Align the drive panel tabs with the side-door hinges.

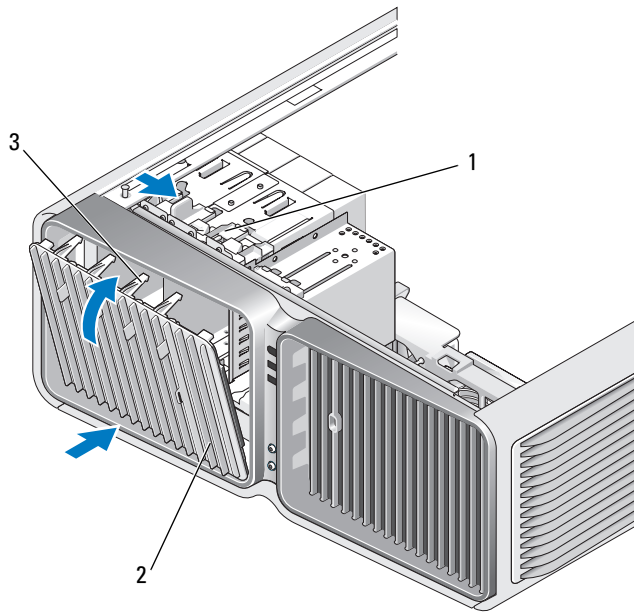

1 drive release latch

2 drive panel

3 drive panel tabs

- 4 Rotate the drive panel toward the computer until it snaps into place on the drive panel.
- 5 Replace the computer cover (see "Replacing the Computer Cover" on page 160).

See the documentation that came with the drive for instructions on installing any software required for drive operation.

Floppy Drive

CAUTION: Before you begin any of the procedures in this section, follow the safety instructions in the *Product Information Guide*.

Removing a Floppy Drive

- 1 Follow the procedures in "Before You Begin" on page 85."
- 2 Remove the computer cover (see "Removing the Computer Cover" on page 86).
- 3 Remove the drive panel (see "Removing the Drive Panel" on page 113).
- 4 Disconnect the power and data cables from the back of the floppy drive.

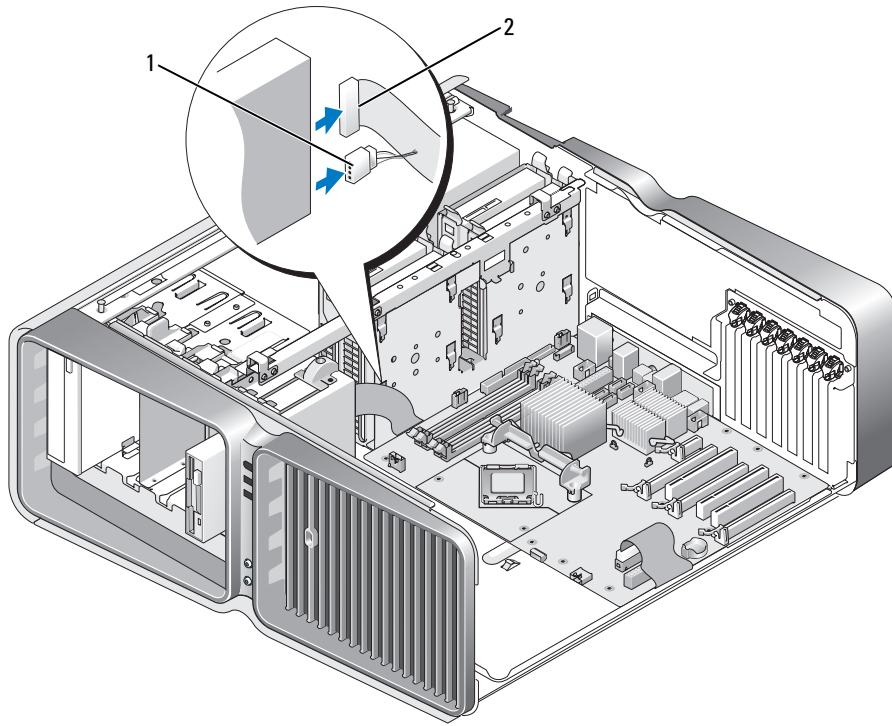

1 power cable

2 floppy drive data cable

- 5 Slide the drive release latch towards the base of the computer to release the shoulder screw, and then slide the drive out of the drive bay.

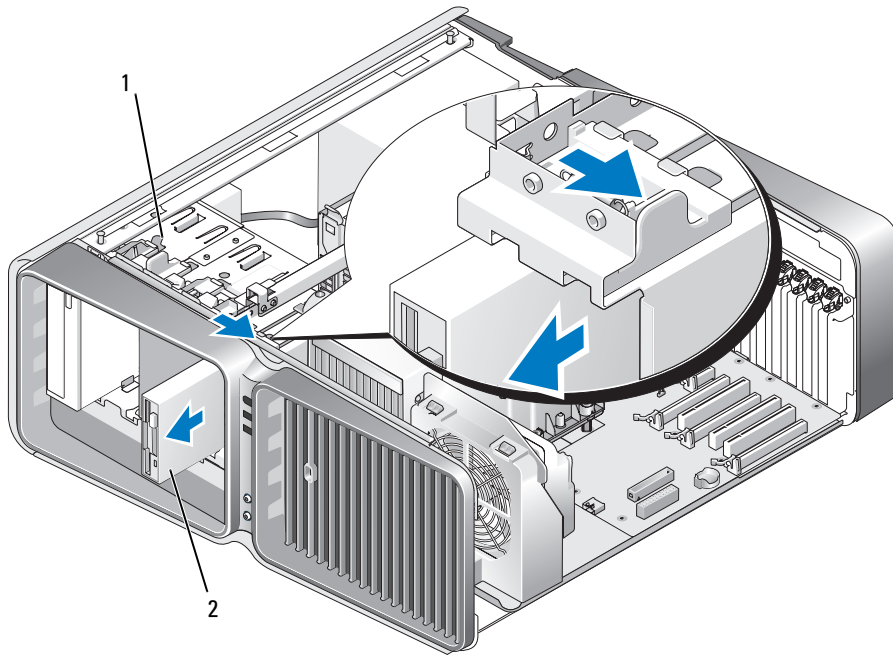

1 drive release latch

2 floppy drive

6 Replace the drive panel (see "Replacing the Drive Panel" on page 114).

7 Replace the computer cover (see "Replacing the Computer Cover" on page 160).

➔ **NOTICE:** To connect a network cable, first plug the cable into the network port or device and then plug it into the computer.

8 Connect the computer and devices to electrical outlets, and turn them on.

Installing a Floppy Drive

1 Follow the procedures in "Before You Begin" on page 85.

2 Remove the computer cover (see "Removing the Computer Cover" on page 86).

3 Remove the drive panel (see "Removing the Drive Panel" on page 113).

4 Remove the existing floppy drive, if applicable (see "Removing a Floppy Drive" on page 115).

5 If no screws are attached to the new floppy drive, check the inside of the drive panel for shoulder screws. If screws are present, attach the screws to the new drive.

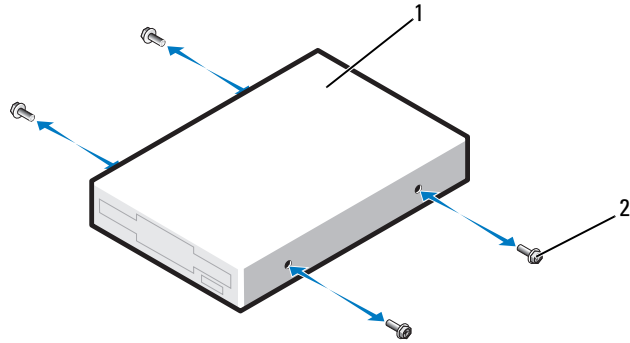

1 floppy drive

2 shoulder screws (4)

6 Slide the floppy drive into the drive bay until it clicks into place.

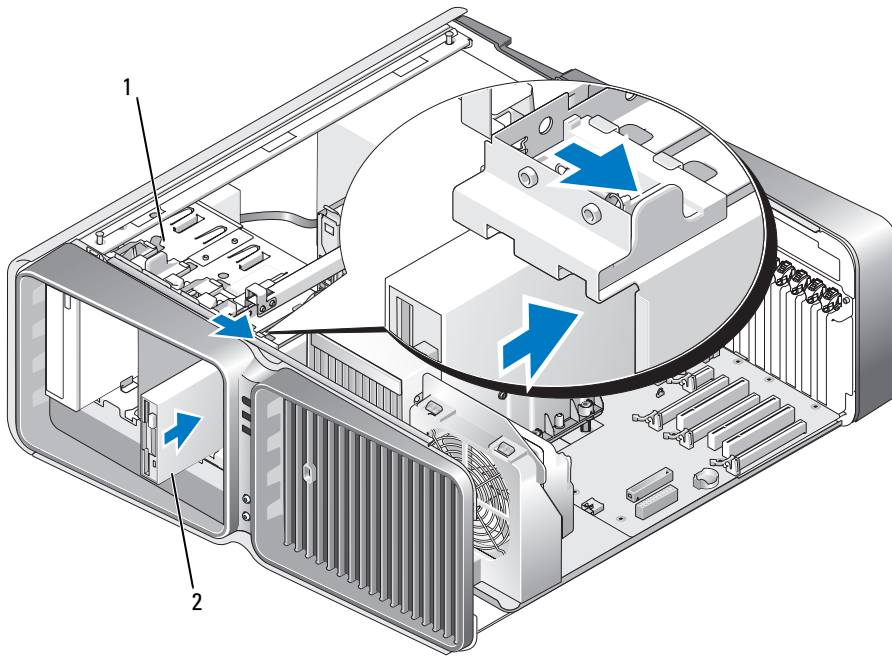

1 drive release latch

2 floppy drive

7 Connect the power and data cables to the back of the floppy drive.

- 8 Check all cable connections and fold cables out of the way to avoid blocking airflow between the fan and cooling vents.
- 9 Replace the drive panel (see "Replacing the Drive Panel" on page 114).
- 10 Replace the computer cover (see "Replacing the Computer Cover" on page 160).
-  **NOTICE:** To connect a network cable, first plug the cable in to the network port or device and then plug it in to the computer.
- 11 Connect your computer and devices to their electrical outlets, and turn them on.
See the documentation that came with the drive for instructions on installing any software required for drive operation.
- 12 Enter system setup (see "Entering System Setup" on page 168), and select the appropriate **Diskette Drive** option.

Media Card Reader



CAUTION: Before you begin any of the procedures in this section, follow the safety instructions in the *Product Information Guide*.

Removing a Media Card Reader

- 1 Follow the procedures in "Before You Begin" on page 85.
- 2 Remove the computer cover (see "Removing the Computer Cover" on page 86).
- 3 Remove the drive panel (see "Removing the Drive Panel" on page 113).
- 4 Disconnect the power and data cables from the back of the Media Card Reader.

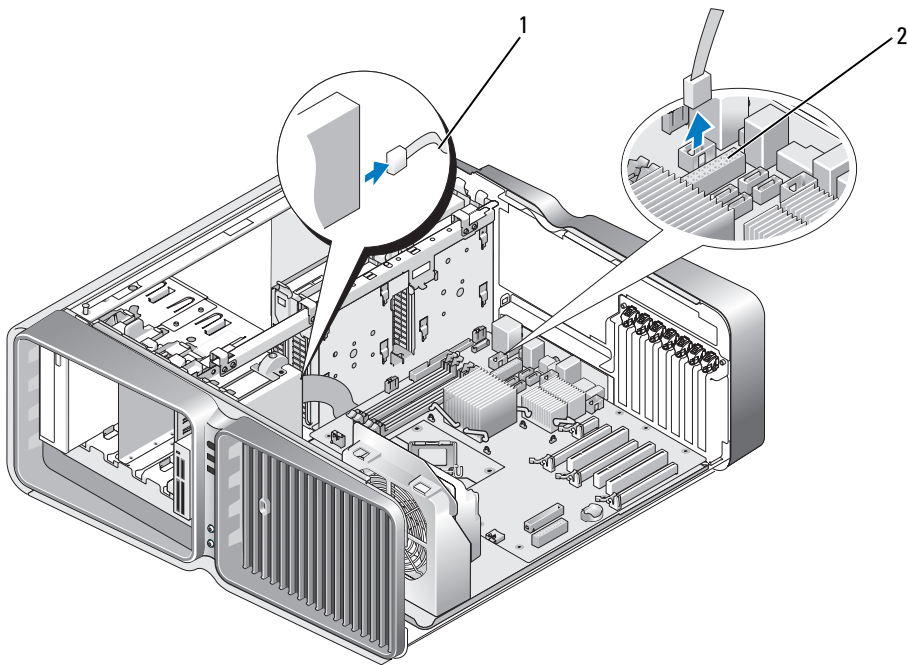

1 media card reader power cable

2 system board connector cable

- 5 Slide the drive release latch towards the base of the computer to release the shoulder screw, and then slide the media card reader out of the drive bay.

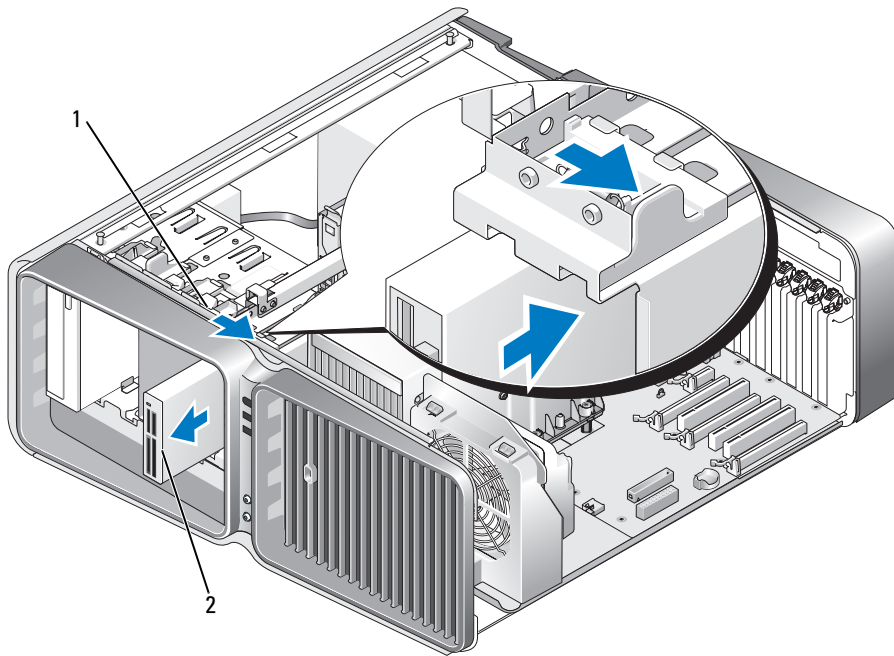

1 drive release latch

2 media card reader

6 Replace the drive panel (see "Replacing the Drive Panel" on page 114).

7 Replace the computer cover (see "Replacing the Computer Cover" on page 160).

➔ NOTICE: To connect a network cable, first plug the cable into the network port or device and then plug it into the computer.

8 Connect the computer and devices to electrical outlets, and turn them on.

Installing a Media Card Reader

1 Follow the procedures in "Before You Begin" on page 85.

2 Remove the computer cover (see "Removing the Computer Cover" on page 86).

3 Remove the drive panel (see "Removing the Drive Panel" on page 113).

4 Remove the existing media card reader, if applicable (see "Removing a Media Card Reader" on page 119).

5 If no screws are attached to the Media Card Reader, check the inside of the drive panel for shoulder screws. If screws are present, attach the screws to the new card reader.

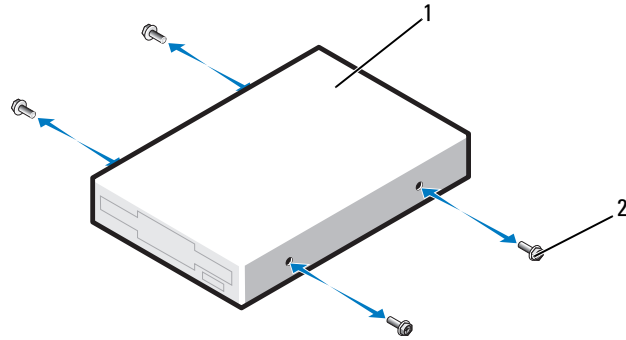

1 media card reader 2 shoulder screws (4)

6 Slide the Media Card Reader into the drive bay until it clicks into place.

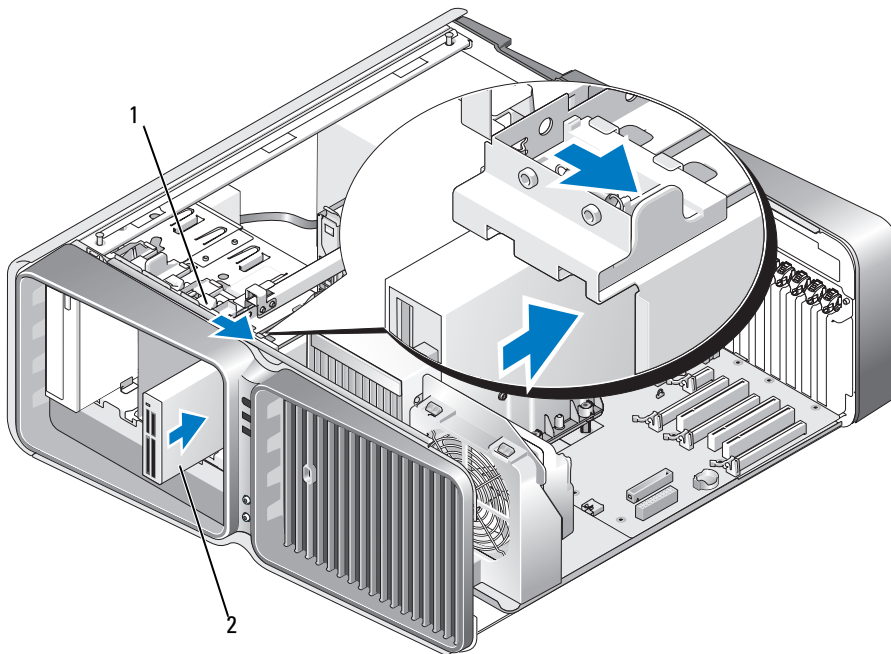

1 drive release latch 2 media card reader

7 Attach the power and data cables to the back of the Media Card Reader.

- 8 Check all cable connections and fold cables out of the way to avoid blocking airflow between the fan and cooling vents.
- 9 Replace the drive panel (see "Replacing the Drive Panel" on page 114).
- 10 Replace the computer cover (see "Replacing the Computer Cover" on page 160).
-  **NOTICE:** To connect a network cable, first plug the cable in to the network port or device and then plug it in to the computer.
- 11 Connect your computer and devices to their electrical outlets, and turn them on.
See the documentation that came with the drive for instructions on installing any software required for drive operation.
- 12 Enter system setup (see "Entering System Setup" on page 168) and select the appropriate USB for FlexBay option.

Optical Drive

 **CAUTION:** Before you begin any of the procedures in this section, follow the safety instructions in the *Product Information Guide*.

Removing an Optical Drive

- 1 Follow the procedures in "Before You Begin" on page 85.
- 2 Remove the computer cover (see "Removing the Computer Cover" on page 86).
- 3 Remove the drive panel (see "Removing the Drive Panel" on page 113).
- 4 Disconnect the power and data cables from the back of the drive.
 **NOTE:** If you are uninstalling your only optical drive and will not replace it at this time, disconnect the data cable from the system board and set it aside.

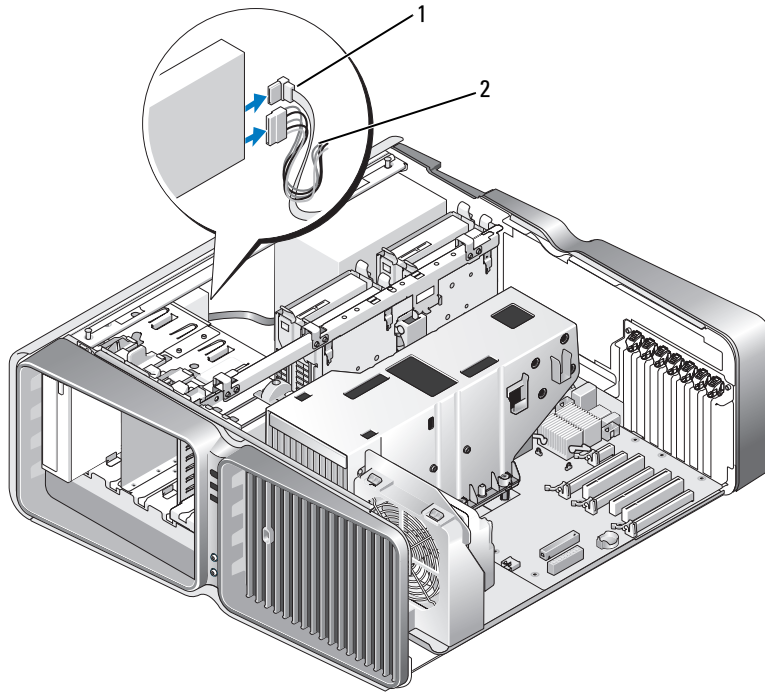

1 data cable

2 power cable

- 5 Slide the drive release latch towards the base of the computer to release the shoulder screw, and then slide the optical drive out of the drive bay.

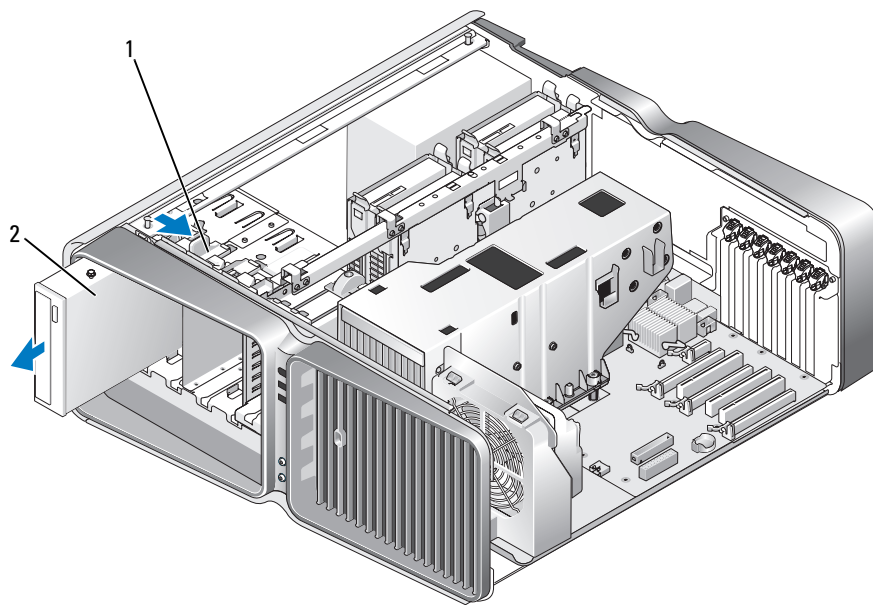

1 drive release latch

2 optical drive

6 Replace the drive panel (see "Replacing the Drive Panel" on page 114).

7 Replace the computer cover (see "Replacing the Computer Cover" on page 160).

➡ NOTICE: To connect a network cable, first plug the cable into the network port or device and then plug it into the computer.

8 Connect the computer and devices to electrical outlets, and turn them on.

Installing an Optical Drive

1 Follow the procedures in "Before You Begin" on page 85.

2 Remove the computer cover (see "Removing the Computer Cover" on page 86).

3 Remove the drive panel (see "Removing the Drive Panel" on page 113).

4 Remove the existing optical drive, if applicable (see "Removing an Optical Drive" on page 123).

5 Prepare the optical drive for installation and check the documentation that accompanied the drive to verify that the drive is configured for your computer.

🔧 NOTE: If you are installing an IDE drive, configure the drive for the cable select setting.

6 If no screws are attached to the drive, check the inside of the drive panel for screws and, if screws are present, attach the screws to the new drive.

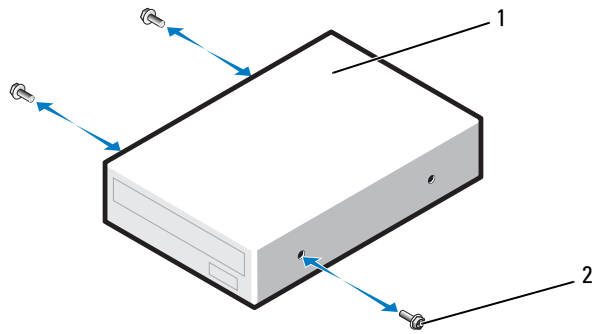

1 optical drive

2 shoulder screws (3)

7 Gently slide the drive into the drive bay until you hear a click or feel the drive securely installed.

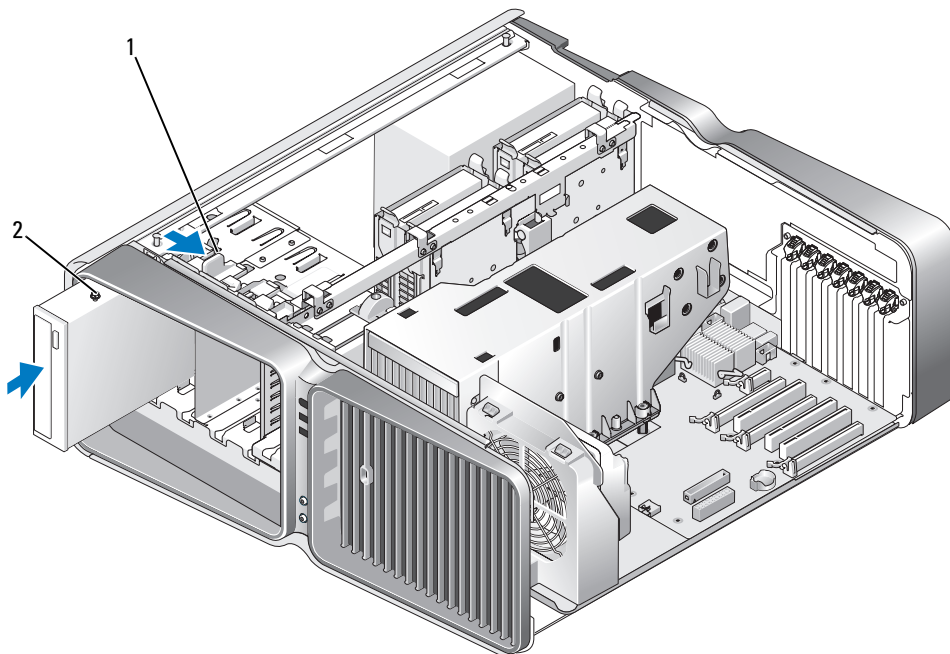

1 drive release latch

2 optical drive

- 8 Attach the power and data cables to the optical drive.

To locate the system board connector, see "System Board Components" on page 89.

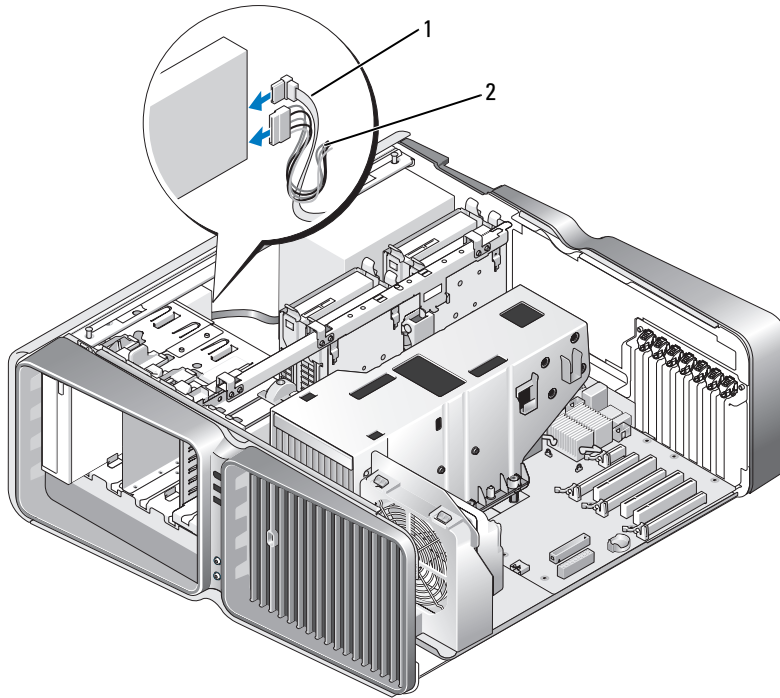

1 power cable

2 data cable

- 9 Check all cable connections and fold cables out of the way to avoid blocking airflow between the fan and cooling vents.
- 10 Replace the drive panel (see "Replacing the Drive Panel" on page 114).
- 11 Replace the computer cover (see "Replacing the Computer Cover" on page 160).
- ➔ **NOTICE:** To connect a network cable, first plug the cable in to the network port or device and then plug it in to the computer.
- 12 Connect your computer and devices to their electrical outlets, and turn them on.
See the documentation that came with the drive for instructions on installing any software required for drive operation.
- 13 Enter system setup (see "Entering System Setup" on page 168) and select the appropriate Drive option.

Liquid Cooling Assembly

 **CAUTION:** Before you perform this procedure, follow the safety instructions located in "Safety Instructions for Liquid Cooling Assembly" on page 128 and the *Product Information Guide*.

Safety Instructions for Liquid Cooling Assembly

- The liquid cooling assembly is not user serviceable or upgradeable. All required service should be done by qualified service personnel only.
- The liquid cooling assembly in your system contains a non-refillable coolant. In the event of a coolant leak, shut down your system immediately. Unplug your system from the power outlet and contact Dell Technical Support.
- In the event of skin contact with the coolant, wash your skin with soap and water. Seek medical attention if irritation develops.
- In the event of eye contact with the coolant, rinse your eyes immediately with water, with your eyelids open, for 15 minutes. Seek medical attention if irritation persists.

Removing the Liquid Cooling Assembly

- 1 Follow the procedures in "Before You Begin" on page 85.
- 2 Remove the computer cover (see "Removing the Computer Cover" on page 86).

 **CAUTION:** The processor heat sink can get very hot during normal operation. Be sure that the heat sink has had sufficient time to cool before you touch it.

- 3 Remove the drive panel (see "Removing the Drive Panel" on page 113).
- 4 Slide the drive release latch towards the base of the computer to release the shoulder screw(s) on the optical drive(s), then slide the optical drive(s) forward, out of the way.

 **NOTE:** It is not necessary to disconnect the optical drive cables unless you intend to fully remove the optical drive(s) from the computer. For information on how to remove an optical drive, see "Removing an Optical Drive" on page 123.

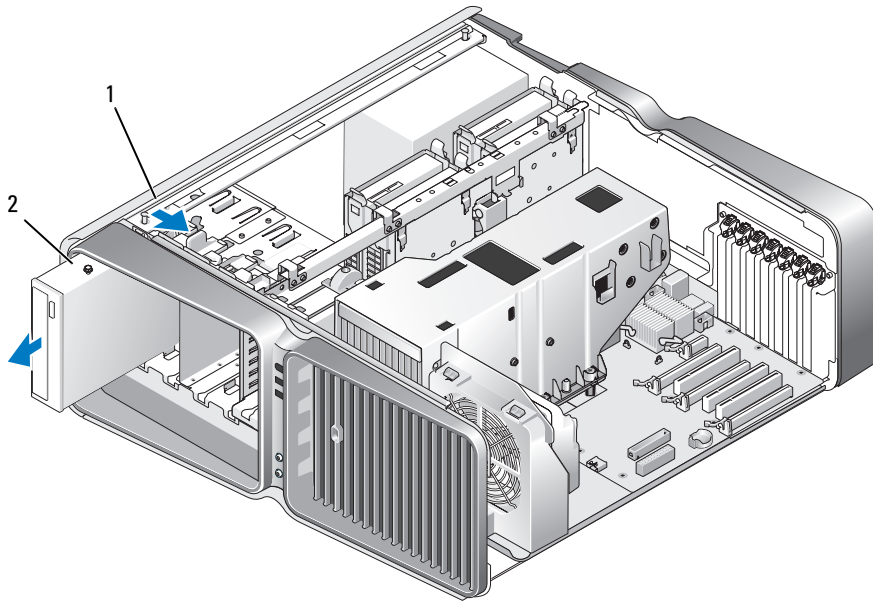

1 drive release latch

2 optical drive

- 5 Remove any full-length expansion cards (see "Removing PCI and PCI Express Cards" on page 95).
- 6 Disconnect the liquid cooling assembly power cable.
- 7 Disconnect the liquid cooling assembly cable from the TEC_PUMP connector on the system board (see "System Board Components" on page 89).

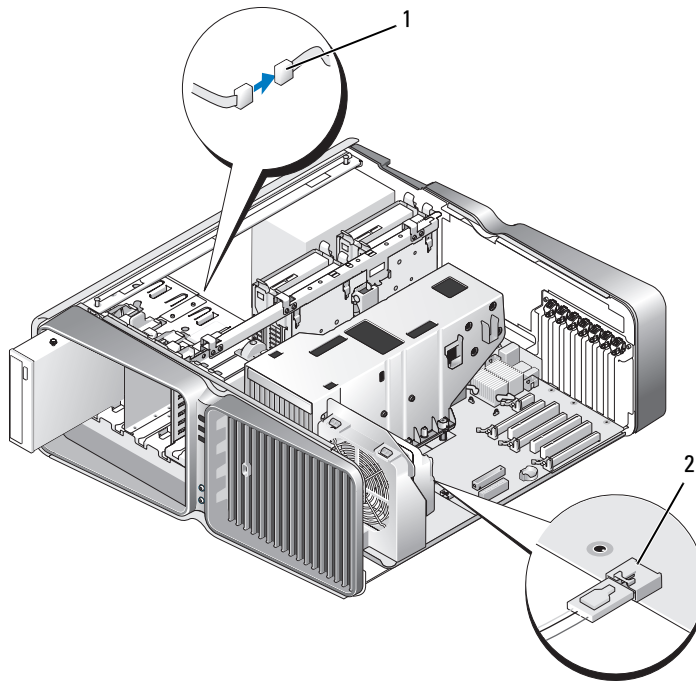

1 power cable

2 TEC_PUMP

8 Disconnect the fan cable from the FAN1_CPU connector on the system board (see "System Board Components" on page 89).

➔ **NOTICE:** The processor heat sink is attached to the liquid cooling assembly. When you remove the liquid cooling assembly, lay it upside down or on its side to avoid damaging the heatsink thermal interface.

➔ **NOTICE:** The screw at the front of the liquid cooling assembly is not captive. Remove the screw and set it aside in a secure location.

9 Loosen the seven screws on the liquid cooling assembly, then lift the assembly out of the computer and set it aside.

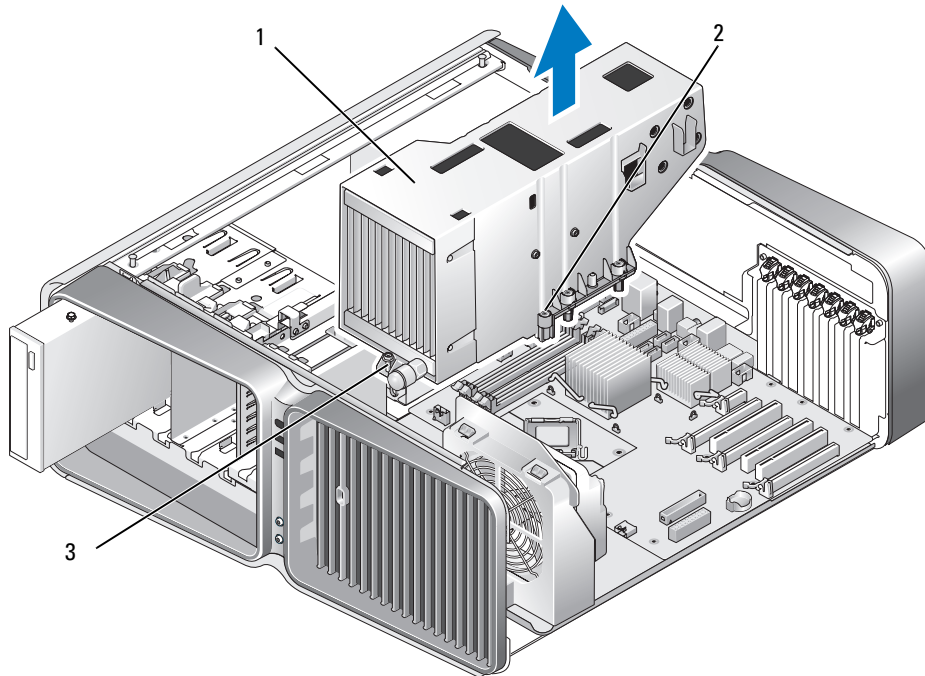

- 1 liquid cooling assembly 2 captive screws (6) 3 screw (loose)

Installing the Liquid Cooling Assembly

- 1 Follow the procedures in "Before You Begin" on page 85.
- 2 Remove the computer cover (see "Removing the Computer Cover" on page 86).
- ➡ **NOTICE:** Ensure that adequate thermal grease is applied to the top of the processor. Thermal grease is critical for ensuring adequate thermal bonding, which is a requirement for optimal processor operation.
- 3 Apply thermal grease to the top of the processor as needed.
- 4 Align the screw holes on the liquid cooling assembly with the holes on the base of the computer, then tighten the seven screws to secure the assembly.
- 5 Connect the fan cable to the FAN1_CPU connector on the system board (see "System Board Components" on page 89).
- 6 Connect the liquid cooling assembly cable to the TEC_PUMP connector on the system board (see "System Board Components" on page 89).
- 7 Connect the liquid cooling assembly power cable.

- 8 Gently slide the optical drive(s) into the drive bay until you hear a click or feel the drive securely installed.
- 9 Replace the drive panel (see "Replacing the Drive Panel" on page 114).
- 10 Replace any expansion cards that you removed (see "Installing PCI and PCI Express Cards" on page 97).
- 11 Close the computer cover (see "Replacing the Computer Cover" on page 160).
-  **NOTICE:** To connect a network cable, first plug the cable into the network port or device and then plug it into the computer.
- 12 Connect your computer and devices to electrical outlets, and turn them on.

Processor



CAUTION: Before you begin any of the procedures in this section, follow the safety instructions in the *Product Information Guide*.



NOTICE: Do not perform the following steps unless you are familiar with hardware removal and replacement. Performing these steps incorrectly could damage your system board.

Removing the Processor

- 1 Follow the procedures in "Before You Begin" on page 85.
- 2 Remove the computer cover (see "Removing the Computer Cover" on page 86).
- 3 Disconnect the power cables from the POWER1 and POWER2 connectors (see "System Board Components" on page 89) on the system board.
- 4 Remove the liquid cooling assembly (see "Removing the Liquid Cooling Assembly" on page 128).
- 5 Push down and out on the socket release lever.

- 6 Lift the socket release lever and open the processor cover.

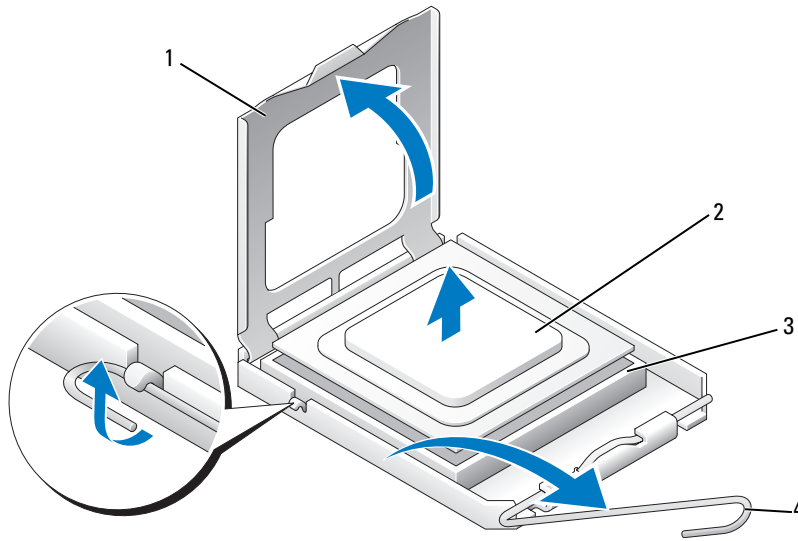

- 1 processor cover 2 processor 3 socket
4 socket release lever

- 7 Remove the processor from the socket.

Leave the release lever extended in the release position so that the socket is ready for the new processor.

Installing the Processor

⚠ NOTICE: Ground yourself by touching an unpainted metal surface on the back of the computer.

- 1 Unpack the new processor.

⚠ NOTICE: You must position the processor correctly in the socket to avoid permanent damage to the processor and the computer when you turn on the computer.

- 2 If the release lever on the socket is not fully extended, move it to that position.

3 Align the pin-1 corner of the processor and socket.

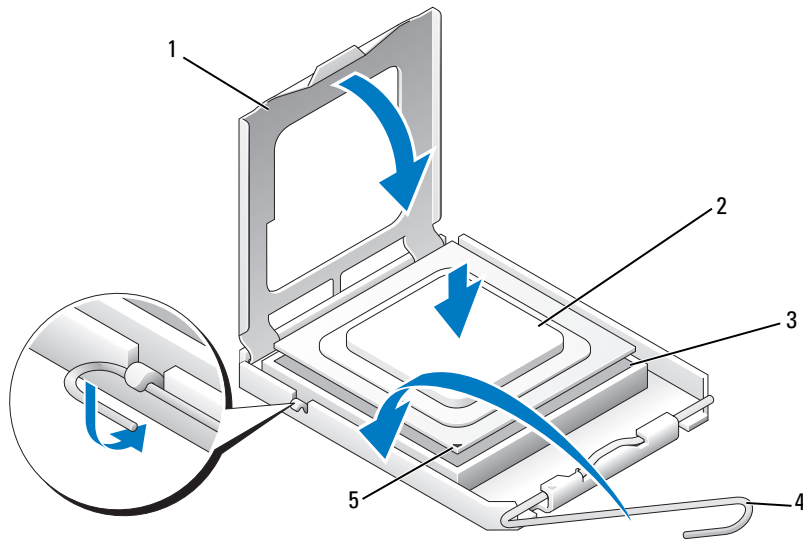

1 processor cover

2 processor

3 socket

4 socket release lever

5 socket pin-1 indicator

➡ **NOTICE:** Socket pins are delicate. To avoid damage, ensure that the processor is aligned properly with the socket, and do not use excessive force when you install the processor. Be careful not to touch or bend the pins on the system board.

4 Set the processor lightly in the socket and ensure that the processor is level in the socket. When the processor is positioned correctly, press it with minimal pressure to seat it.

5 When the processor is fully seated in the socket, close the processor cover.

6 Pivot the socket release lever back toward the socket and snap it into place to secure the processor.

7 Replace the liquid cooling assembly (see "Installing the Liquid Cooling Assembly" on page 131).

8 Reconnect the power cables to the POWER1 and POWER2 connectors (see "System Board Components" on page 89) on the system board.

9 Close the computer cover (see "Replacing the Computer Cover" on page 160).

➡ **NOTICE:** To connect a network cable, first plug the cable into the network port or device and then plug it into the computer.

10 Connect your computer and devices to electrical outlets, and turn them on.

Fans

Removing the Card Fan

- 1 Follow the procedures in "Before You Begin" on page 85.
- 2 Remove the computer cover (see "Removing the Computer Cover" on page 86).
- 3 Remove any full-length expansion cards (see "Removing PCI and PCI Express Cards" on page 95).
- 4 Disconnect the fan cable from the FAN_CAGE connector on the system board (see "System Board Components" on page 89).
- 5 Press down on the two tabs along the top of the fan cage, then slide the fan cage back and out of the cage housing.

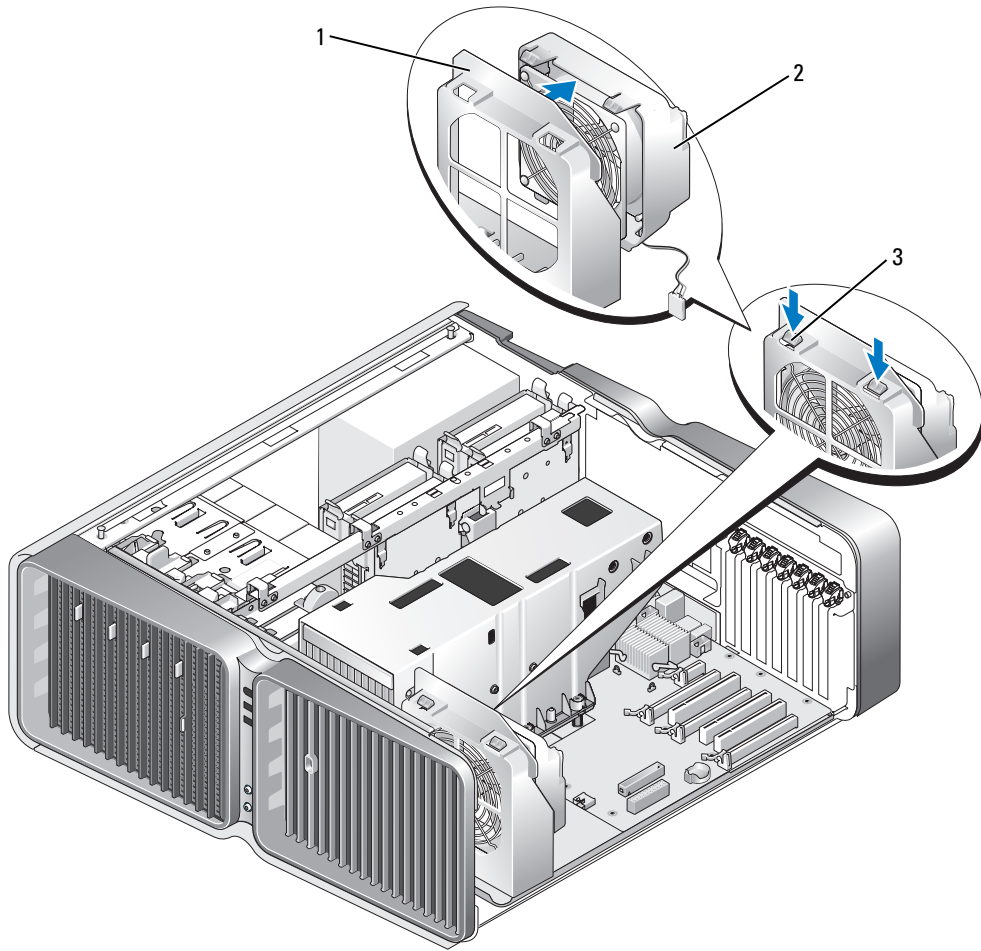

1 cage housing

2 fan cage

3 tab (2)

- 6 In succession, carefully pull on each corner of the fan to detach the rubber grommets securing the fan to the fan cage.

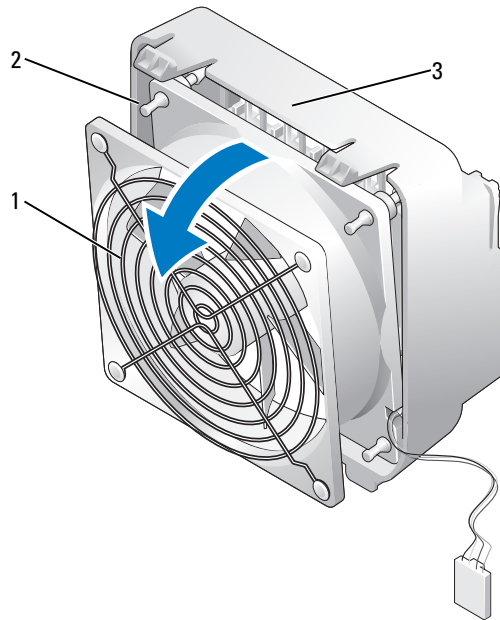

1 card fan

2 rubber grommet (4)

3 fan cage

Installing the Card Fan

➔ NOTICE: Ensure the fan cable is correctly routed through the opening in the lower-right corner of the fan cage.

- 1 With the fan power cable oriented downward, align the rubber grommets in the fan with the holes in each corner of the fan cage, then pull the grommets through until they snap into place.

🔪 NOTE: Airflow direction and orientation are shown on the side of the fan.

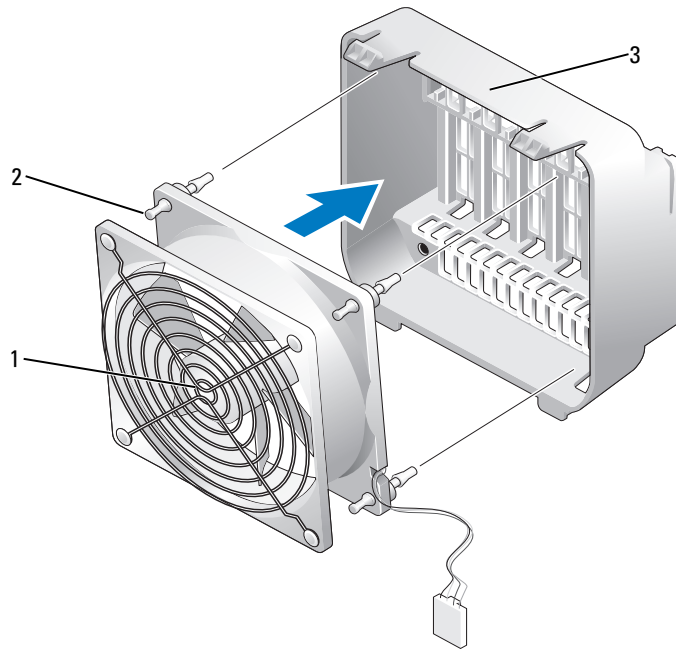

1 card fan 2 rubber grommet (4) 3 fan cage

- 2 Insert the tabs along the bottom of the fan cage into the corresponding slots on the cage housing, then rotate the fan cage forward until it snaps into place.
- 3 Connect the fan cable to the FAN_CAGE connector on the system board (see "System Board Components" on page 89).
- 4 Replace any expansion cards that you removed (see "Installing PCI and PCI Express Cards" on page 97).
- 5 Replace the computer cover (see "Replacing the Computer Cover" on page 160).
- ➔ **NOTICE:** To connect a network cable, first plug the cable into the network port or device and then plug it into your computer.
- 6 Connect your computer and devices to electrical outlets, and then turn them on.

Removing the Optional Hard Drive Fan

- 1 Follow the procedures in "Before You Begin" on page 85.
- 2 Remove the computer cover (see "Removing the Computer Cover" on page 86).
- 3 Remove all installed memory modules (see "Removing Memory" on page 93).

- 4 Disconnect the fan cable from the FAN_HDD connector on the system board (see "System Board Components" on page 89).
- 5 Press the release latch on the hard drive fan and slide it out from between the hard drive bays, then lift it from the computer.

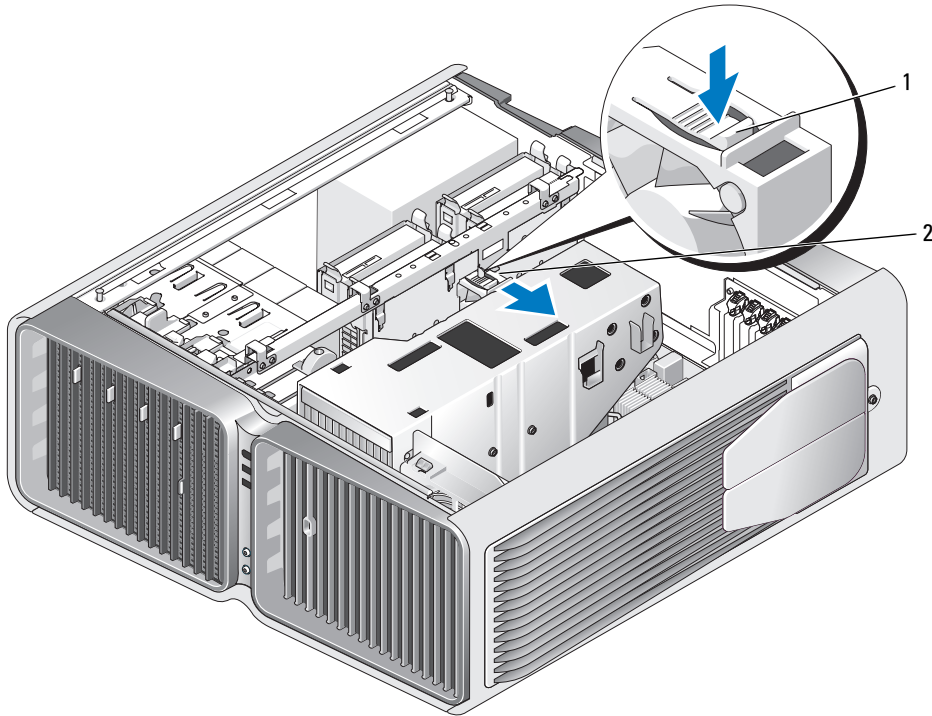

1 hard-drive fan release latch 2 hard drive fan

Installing the Optional Hard Drive Fan

- 1 Slide the fan between the hard drive bays until it snaps into place.
- 2 Connect the fan cable to the FAN_HDD connector on the system board (see "System Board Components" on page 89).
- 3 Replace the computer cover (see "Replacing the Computer Cover" on page 160).

➔ NOTICE: To connect a network cable, first plug the cable into the network port or device and then plug it into your computer.

- 4 Connect your computer and devices to electrical outlets, and then turn them on.

System Board

CAUTION: Before you begin any of the procedures in this section, follow the safety instructions in the *Product Information Guide*

Removing the System Board

NOTICE: The system board and metal tray are connected and are removed as one piece.

- 1 Follow the procedures in "Before You Begin" on page 85.
- 2 Remove the computer cover (see "Removing the Computer Cover" on page 86).
- 3 Disconnect the fan cable from the FAN_CAGE connector on the system board (see "System Board Components" on page 89).
- 4 Remove any full-length expansion cards (see "Removing PCI and PCI Express Cards" on page 95).
- 5 Remove the two screws securing the card fan assembly, then remove the assembly and set it aside.

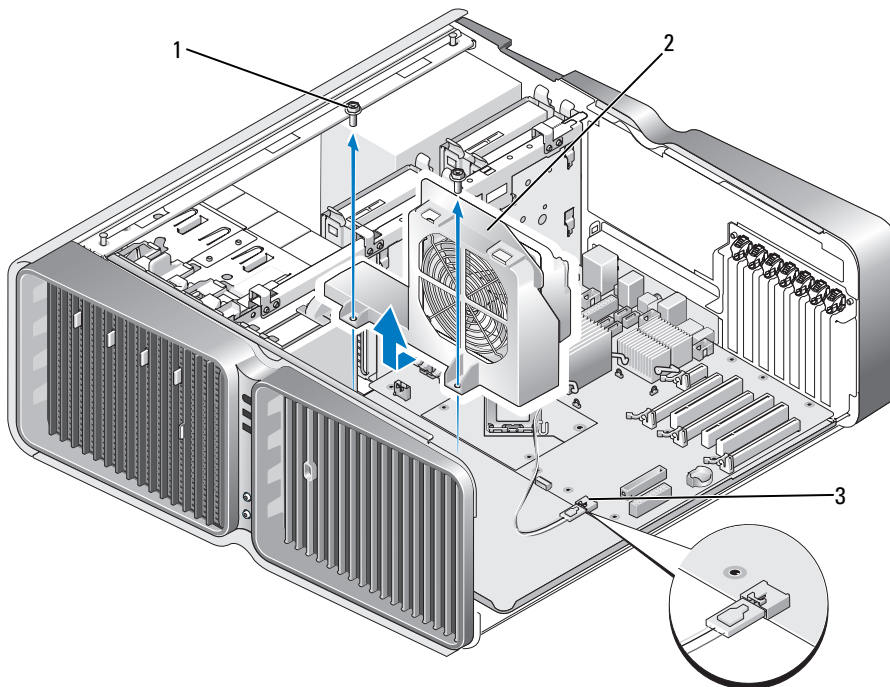

1 screw (2)

2 card fan assembly

3 fan connector

- 6 Remove any additional components that may restrict access to the system board.
- 7 Disconnect all cables from the system board.

- ➔ **NOTICE:** If you are replacing the system board, visually compare the replacement system board to the existing system board to make sure that you have the correct part.
- 8 Remove the two screws securing the system board assembly to the chassis, then pull on the two tabs to slide the system board assembly towards the front of the computer.

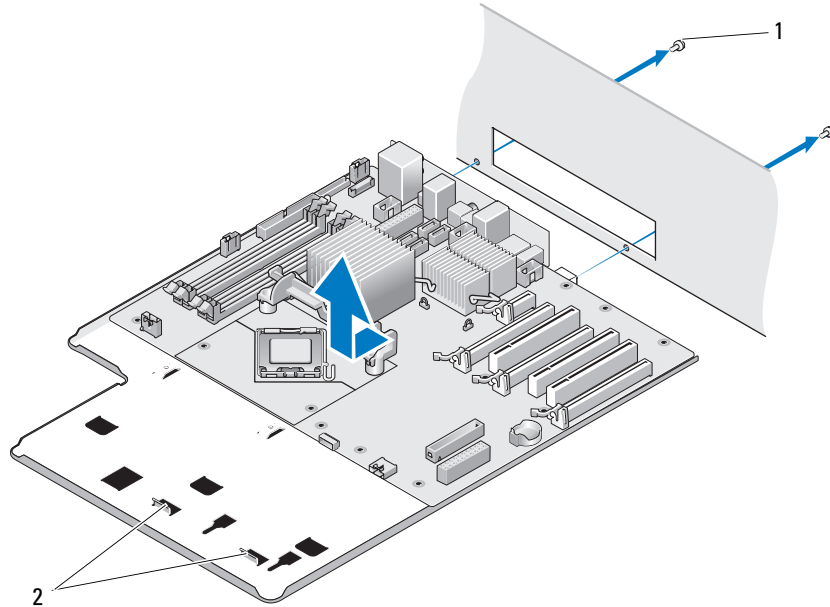

1 screw (2)

2 tabs

- ➔ **NOTICE:** The system board and metal tray are connected and are removed as one piece.
- 9 Carefully, lift the system board assembly up and out of the computer.

Installing the System Board

- ➔ **NOTICE:** The system board and metal tray are connected and are installed as one piece.
- ➔ **NOTICE:** If you are replacing the system board, visually compare the replacement system board to the existing system board to make sure that you have the correct part.
- 🔧 **NOTE:** Some components and connectors on replacement system boards may be in different locations than corresponding connectors on the existing system board.

 **NOTE:** Jumper settings on replacement system boards are preset by the factory.

- 1 Transfer components from the existing system board to the replacement system board, if applicable.
 - 2 Orient the system board assembly by aligning the notches on the bottom of the assembly with the tabs on the computer.
 - 3 Slide the system board assembly toward the back of the computer until the assembly clicks into place.
 - 4 Replace the two screws to secure the system board assembly to the chassis.
 - 5 Align the screw holes on the card fan assembly with the screw holes on the system board assembly, then replace the two screws to secure the card fan assembly.
 - 6 Connect the fan cable to the FAN_CAGE connector on the system board (see "System Board Components" on page 89).
 - 7 Replace any expansion cards that you removed (see "Installing PCI and PCI Express Cards" on page 97).
 - 8 Replace any additional components that you removed from the system board.
 - 9 Reconnect all cables to the system board.
 - 10 Replace the computer cover (see "Replacing the Computer Cover" on page 160).
-  **NOTICE:** To connect a network cable, first plug the cable into the network port or device and then plug it into your computer.
- 11 Connect your computer and devices to electrical outlets, and then turn them on.
 - 12 Flash the system BIOS, as needed.

 **NOTE:** For information on flashing the system BIOS, see support.dell.com.

Power Supply

 **CAUTION:** Before you begin any of the procedures in this section, follow the safety instructions in the *Product Information Guide*.

Power Supply (PSU) DC Connector Pin Assignments

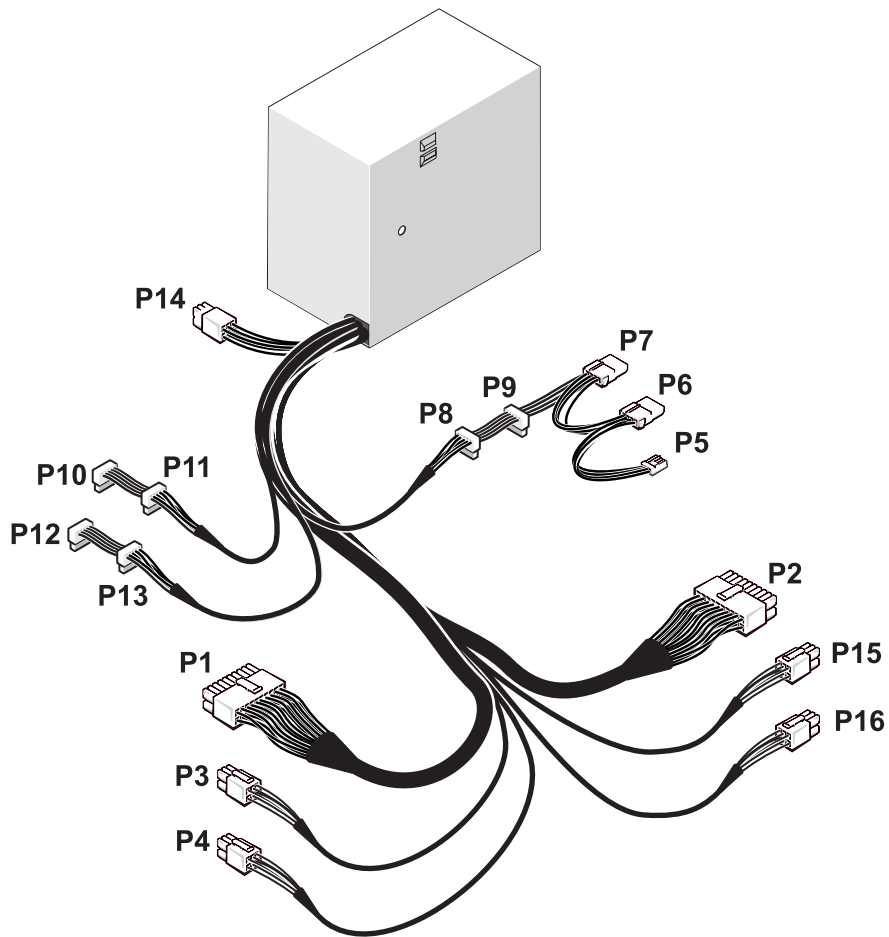

DC Power Connector P1

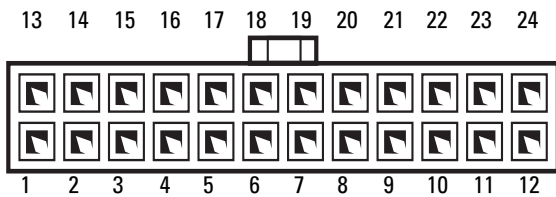

1-KW Power Supply			750-KW Power Supply	
Pin Number	Signal name	18-AWG Wire Color	Signal name	18-AWG Wire Color
1	+3.3 VDC	Orange	+3.3 VDC	Orange
2	+3.3 VDC/SE	Orange	+3.3 VDC/SE	Orange
3	COM	Black	COM	Black
4	+5 VDC	Red	+5 VDC	Red
5	COM	Black	COM	Black
6	+5 VDC	Red	+5 VDC	Red
7	COM	Black	COM	Black
8	POK	Gray	POK	Gray
9	+5 VFP	Purple	+5 VFP	Purple
10	+12 VD DC/SE	Yellow/White	+12 VD DC/SE	Yellow/White
11	+12 VD DC	Yellow/White	+12 VD DC	Yellow/White
12	+3.3 VDC	Orange	+3.3 VDC	Orange
13	+3.3 VDC	Orange	+3.3 VDC	Orange
14	-12 VDC	Blue	-12 VDC	Blue
15	COM	Black	COM	Black
16	PS_ON	Green	PS_ON	Green
17	COM	Black	COM	Black
18	COM	Black	COM	Black

1-KW Power Supply			750-KW Power Supply	
Pin Number	Signal name	18-AWG Wire Color	Signal name	18-AWG Wire Color
19	COM	Black	COM	Black
20	N/C	N/A	N/C	N/A
21	+5 VDC/SE	Red	+5 VDC/SE	Red
22	+5 VDC	Red	+5 VDC	Red
23	+5 VDC	Red	+5 VDC	Red
24	COM	Black	COM	Black

DC Power Connector P2

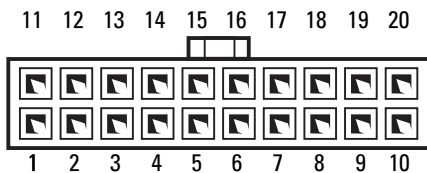

1-KW Power Supply			750-KW Power Supply	
Pin Number	Signal name	18-AWG Wire Color	Signal name	18-AWG Wire Color
1	+12 VC DC	Blue/White	+12 VC DC	Blue/White
2	+12 VC DC	Blue/White	+12 VC DC	Blue/White
3	COM	Black	COM	Black
4	COM	Black	COM	Black
5	+12 VA DC/SE	Yellow	+12 VA DC/SE	Yellow

1-KW Power Supply			750-KW Power Supply	
Pin Number	Signal name	18-AWG Wire Color	Signal name	18-AWG Wire Color
6	+12 VA DC	Yellow	+12 VA DC	Yellow
7	COM	Black	COM	Black
8	COM	Black	COM	Black
9	+12 VB DC/SE	White	+12 VB DC/SE	White
10	+12 VB DC	White	+12 VB DC	White
11	+12 VC DC/SE	Blue/White	+12 VC DC/SE	Blue/White
12	COM	Black	COM	Black
13	COM	Black	COM	Black
14	COM	Black	COM	Black
15	+12 VA DC	Yellow	+12 VA DC	Yellow
16	COM	Black	COM	Black
17	COM	Black	COM	Black
18	COM	Black	COM	Black
19	+12 VB DC	White	+12 VB DC	White
20	NC	N/A	NC	N/A

DC Power Connector P3 (Graphics Card)

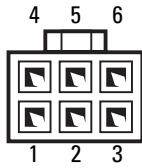

1-KW Power Supply			750-KW Power Supply	
Pin Number	Signal name	18-AWG Wire Color	Signal name	18-AWG Wire Color
1	+12 VE DC/SE	Blue/Yellow	+12 VB DC	White
2	+12 VE DC	Blue/Yellow	+12 VB DC	White
3	+12 VE DC	Blue/Yellow	+12 VB DC	White
4	COM	Black	COM	Black
5	COM	Black	COM	Black
6	COM	Black	COM	Black

DC Power Connector P4 (Graphics Card)

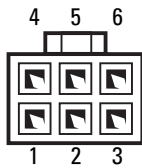

1-KW Power Supply			750-KW Power Supply	
Pin Number	Signal name	18-AWG Wire Color	Signal name	18-AWG Wire Color
1	+12 VE DC	Blue/Yellow	+12 VC DC	Blue/White
2	+12 VE DC	Blue/Yellow	+12 VC DC	Blue/White
3	+12 VE DC	Blue/Yellow	+12 VC DC	Blue/White
4	COM	Black	COM	Black
5	COM	Black	COM	Black
6	COM	Black	COM	Black

 **NOTE:** The P3 and P4 connectors are intended for use with the PCI Express graphics cards whose power requirements exceed 75 watts.

DC Power Connector P5 (FD1)

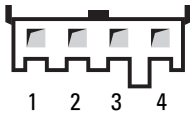

1-KW Power Supply			750-KW Power Supply	
Pin Number	Signal name	22-AWG Wire Color	Signal name	22-AWG Wire Color
1	+5 VDC	Red	+5 VDC	Red
2	COM	Black	COM	Black
3	COM	Black	COM	Black
4	+12 VE DC	Blue/Yellow	+12 VB DC	White

DC Power Connector P6 and P7 (BAY1 and Bay2)

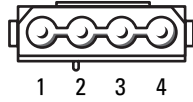

1-KW Power Supply			750-KW Power Supply	
Pin Number	Signal name	18-AWG Wire Color	Signal name	18-AWG Wire Color
1	+12 VE DC	Blue/Yellow	+12 VB DC	White
2	COM	Black	COM	Black
3	COM	Black	COM	Black
4	+5 VDC	Red	+5 VDC	Red

DC Power Connectors P8 and P9 (HDD0 and HDD1)

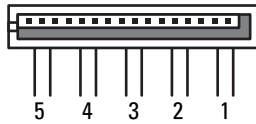

1-KW Power Supply			750-KW Power Supply	
Pin Number	Signal name	18-AWG Wire Color	Signal name	18-AWG Wire Color
1	+3.3 VDC	Orange	+3.3 VDC	Orange
2	COM	Black	COM	Black
3	+5 VDC	Red	+5 VDC	Red
4	COM	Black	COM	Black
5	+12 VE DC	Blue/Yellow	+12 VB DC	White

DC Power Connectors P10-P13 (HDD2 and HDD5)

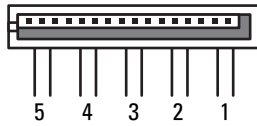

1-KW Power Supply			750-KW Power Supply	
Pin Number	Signal name	18-AWG Wire Color	Signal name	18-AWG Wire Color
1	+3.3 VDC	Orange	+3.3 VDC	Orange
2	COM	Black	COM	Black
3	+5 VDC	Red	+5 VDC	Red
4	COM	Black	COM	Black
5	+12 VE DC	Blue/Yellow	+12 VC DC	Blue/White

DC Power Connectors P14 (Peripheral)

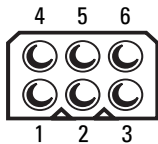

1-KW Power Supply			750-KW Power Supply	
Pin Number	Signal name	18-AWG Wire Color	Signal name	18-AWG Wire Color
1	+12 VB DC	White	+12 VA DC	Yellow
2	COM	Black	COM	Black
3	COM	Black	COM	Black

1-KW Power Supply			750-KW Power Supply	
Pin Number	Signal name	18-AWG Wire Color	Signal name	18-AWG Wire Color
4	+3.3 VDC	Orange	+3.3 VDC	Orange
5	+5 VDC	Red	+5 VDC	Red
6	+12 VC DC	Blue/White	+12 VD DC	Yellow/White

DC Power Connector P15 (Graphics Card – 1-KW PSU Only)

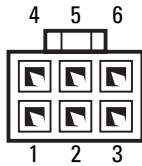

Pin Number	Signal Name	18-AWG Wire Color
1	+12 VB DC	White
2	+12 VB DC	White
3	+12 VB DC	White
4	COM	Black
5	COM	Black
6	COM	Black

DC Power Connector P16 (Graphics Card – 1-KW PSU Only)

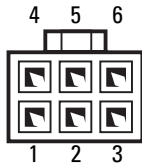

Pin Number	Signal Name	18-AWG Wire Color
1	+12 VC DC	Blue/White
2	+12 VC DC	Blue/White
3	+12 VC DC	Blue/White
4	COM	Black
5	COM	Black
6	COM	Black

 **NOTE:** The P15 and P16 connectors are intended for use with the PCI Express graphics cards whose power requirements exceed 75 watts.

Removing the Power Supply

- 1 Follow the procedures in "Before You Begin" on page 85.
- 2 Remove the computer cover (see "Removing the Computer Cover" on page 86).
-  **NOTICE:** Note the location and ID of each power connector before disconnecting the power supply cables.
- 3 Follow the DC power cables that stem from the power supply and disconnect each connected power cable.

 **NOTE:** Note the routing of the power cable bundles as you disconnect them. You must route these cables properly when you replace them to prevent them from being pinched or crimped.

- 4 Remove all hard drives installed in the interior hard drive bays (see "Removing a Hard Drive" on page 108).
- 5 Remove the optional hard drive fan, if applicable (see "Removing the Optional Hard Drive Fan" on page 138).
- 6 Remove the two screws that attach each hard drive bay.

7 Remove the hard drive bays from the chassis.

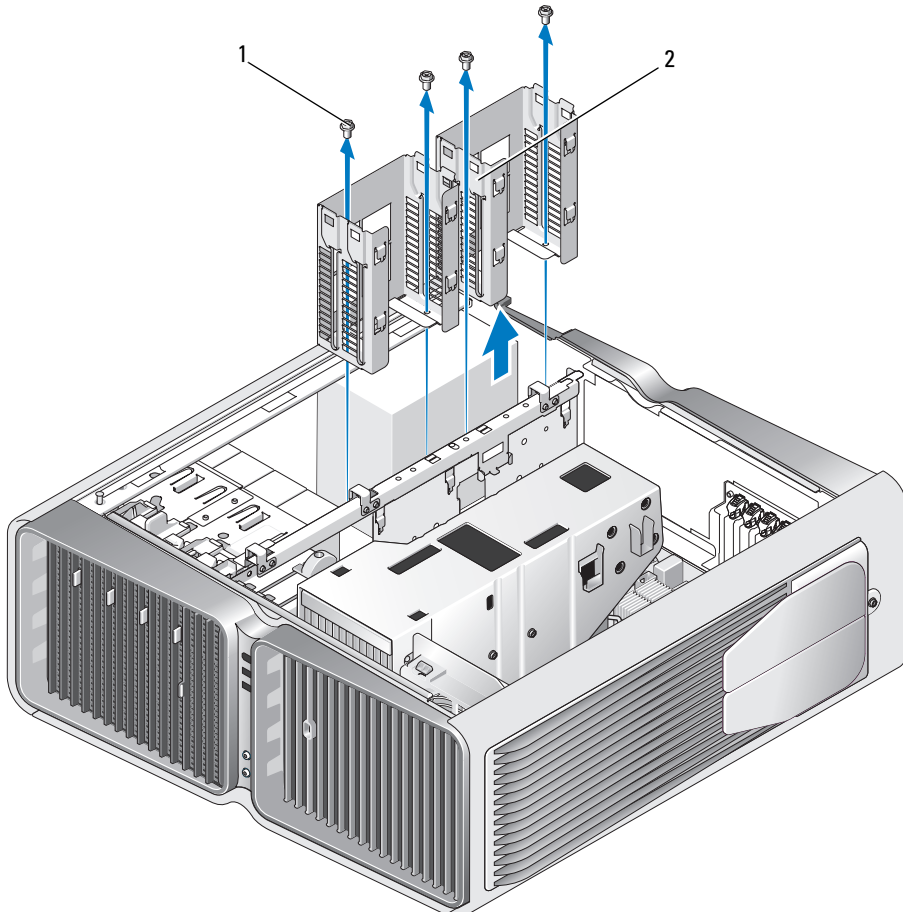

1 screws (4)

2 hard-drive bays

8 Remove the four screws that attach the power supply to the back of the computer chassis.

9 Gather the power supply bundles that stem from the power supply, for easy removal.

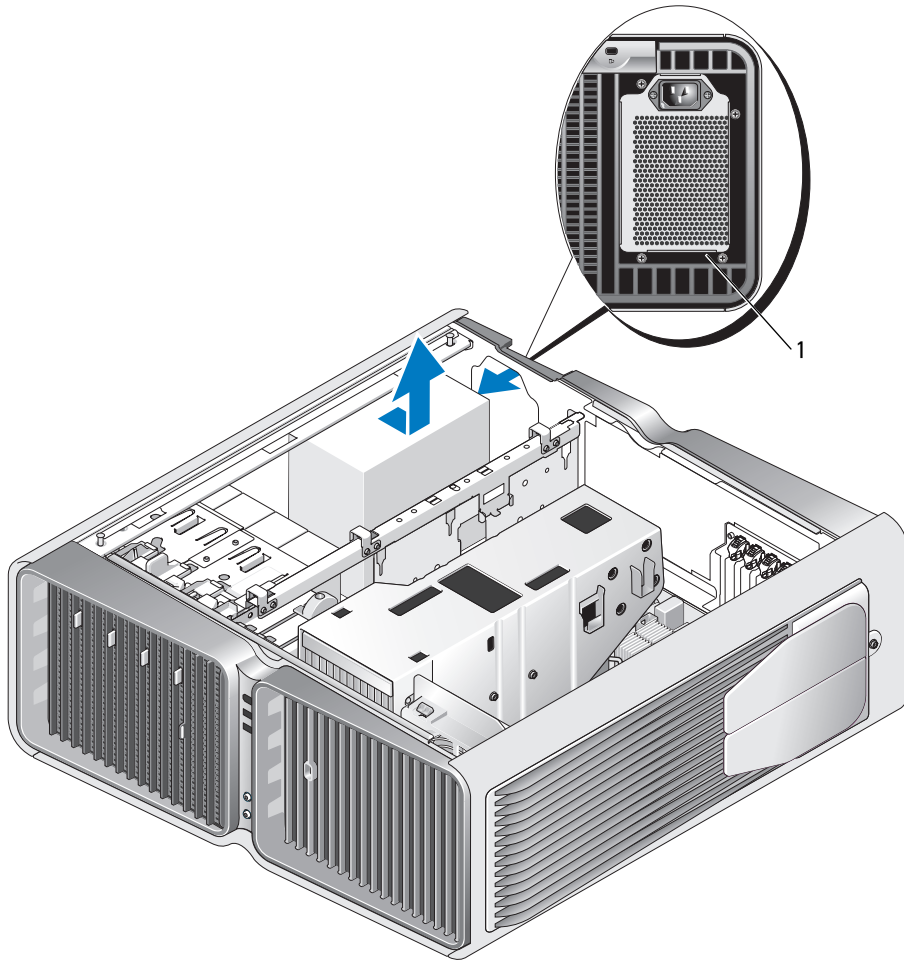

1 power supply screws (4)

- 10 Slide the power supply towards the front of the computer to free it from the securing tabs on the computer chassis.
- 11 Slide the power supply toward the hard drive bay area, so that it will clear the protruding lip of the chassis and lift the power supply from the computer.

Installing the Power Supply

- 1 Slide the power supply into place, ensuring that the tabs on the rear wall of the computer chassis latch into place.
 - 2 Replace the four screws that secure the power supply to the back of the computer chassis.
 - 3 Replace the two hard drive bays.
 - 4 Replace all hard drives installed in the interior hard drive bays (see "Installing a Hard Drive" on page 110).
 - 5 Replace the optional hard drive fan, if applicable (see "Installing the Optional Hard Drive Fan" on page 139).
 - 6 Reattach each of the DC power cables that were previously connected, carefully rerouting them as you found them.
 - 7 Replace the computer cover (see "Replacing the Computer Cover" on page 160).
-  **NOTICE:** To connect a network cable, first plug the cable into the network port or device and then plug it into the computer.
- 8 Connect your computer and devices to electrical outlets, and then turn them on.

Front I/O Panel

Front I/O-Panel Components

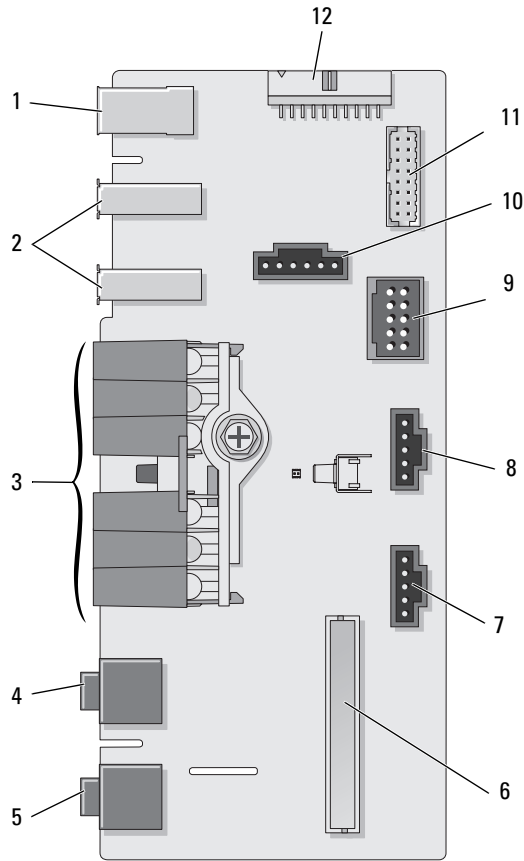

- | | | | | | |
|----|-------------------------|----|-------------------------|----|---|
| 1 | external IEEE 1394 port | 2 | external USB ports (2) | 3 | power, diagnostics, hard drive, and network activity LEDs |
| 4 | headphone connector | 5 | microphone connector | 6 | internal front panel I/O connector |
| 7 | bottom LED connector | 8 | top LED connector | 9 | internal USB connector |
| 10 | power button connector | 11 | internal 1394 connector | 12 | internal audio interface connector |

Removing the Front I/O Panel

⚠ CAUTION: Before you begin any of the procedures in this section, follow the safety instructions in the *Product Information Guide*.

- 1 Follow the procedures in "Before You Begin" on page 85.
- 2 Remove the computer cover (see "Removing the Computer Cover" on page 86).
- 3 Remove any full-length expansion cards (see "Removing PCI and PCI Express Cards" on page 95).

➡ NOTICE: Carefully note the routing of each cable before you disconnect it, so that you are sure to re-route cables correctly. An incorrectly routed or a disconnected cable could lead to computer problems.

- 4 Remove the processor airflow shroud (see "Removing the Liquid Cooling Assembly" on page 128).
- 5 Disconnect the front fan and the card fan from the system board.
- 6 Unscrew the two screws that hold the processor and card fan assembly in place and lift it away from the computer.
- 7 Disconnect the control-panel cable from the I/O panel connector by pulling the cable loop.

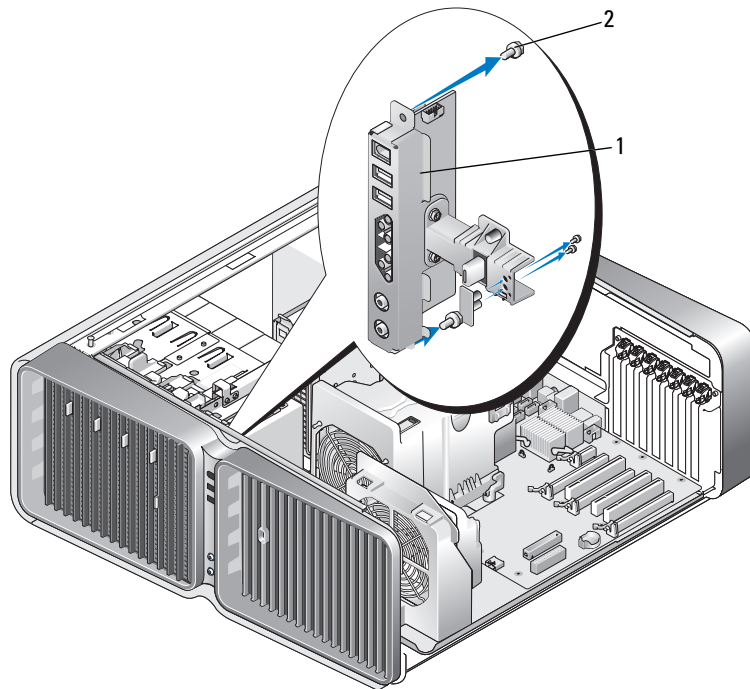

1 Front I/O panel

2 mounting screws (4)

- 8 Remove the four mounting screws from the I/O panel.
- 9 Lift to remove the I/O panel from the computer.

Installing the I/O Panel



CAUTION: Before you begin any of the procedures in this section, follow the safety instructions in the *Product Information Guide*.



NOTICE: Ensure that you replace all cables originally attached to the I/O panel or your computer may not function properly.

- 1 Follow the procedures in "Before You Begin" on page 85.
- 2 Remove the computer cover (see "Removing the Computer Cover" on page 86).
- 3 Align the screw holes on the I/O panel with the screw holes on the chassis, and then tighten the four mounting screws.
- 4 Connect the control-panel cable to the I/O panel connector.
- 5 Replace the processor and card fan assembly.
- 6 Connect the front fan and the card fan to the system board.
- 7 Replace the liquid cooling assembly (see "Installing the Liquid Cooling Assembly" on page 131).
- 8 Replace any full-length expansion cards (see "Installing PCI and PCI Express Cards" on page 97) that were uninstalled during removal of the I/O panel.
- 9 Replace the computer cover (see "Replacing the Computer Cover" on page 160).

Battery



CAUTION: Before you begin any of the procedures in this section, follow the safety instructions in the *Product Information Guide*.

Replacing the Battery

A coin-cell battery maintains computer configuration, date, and time information. The battery can last several years.

If you have to repeatedly reset time and date information after turning on the computer, replace the battery.



CAUTION: A new battery can explode if it is incorrectly installed. Replace the battery only with the same or equivalent type recommended by the manufacturer. Discard used batteries according to the manufacturer's instructions.

To replace the battery:

- 1 Record all the screens in system setup (see "System Setup" on page 168) so that you can restore the correct settings after the new battery has been installed.
- 2 Follow the procedures in "Before You Begin" on page 85.

3 Open the computer cover (see "Removing the Computer Cover" on page 86).

4 Locate the battery socket (see "System Board Components" on page 89).

NOTICE: If you pry the battery out of its socket with a blunt object, be careful not to touch the system board with the object. Ensure that the object is inserted between the battery and the socket before you attempt to pry out the battery. Otherwise, you may damage the system board by prying off the socket or by breaking circuit traces on the system board.

5 Remove the battery by prying it out of its socket with your fingers.

6 Insert the new battery (CR2032) into the socket with the side labeled "+" facing up, and press the battery into place.

7 Replace the computer cover (see "Replacing the Computer Cover" on page 160).

NOTICE: To connect a network cable, first plug the cable into the network port or device and then plug it into the computer.

8 Connect your computer and devices to electrical outlets, and turn them on.

9 Enter system setup (see "System Setup" on page 168) and restore the settings you recorded in step 1.

10 Properly dispose of the old battery. See the *Product Information Guide* for battery disposal information.

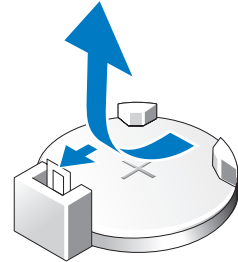

Removing the Computer Stand

CAUTION: Before you begin any of the procedures in this section, follow the safety instructions in the *Product Information Guide*.

CAUTION: Your computer is heavy and can be difficult to maneuver. Seek assistance before attempting to lift, move, or tilt the computer and always lift correctly to avoid injury; avoid bending over while lifting.

CAUTION: The computer stand should be installed at all times to ensure maximum system stability. Failure to install the stand could result in the computer tipping over, potentially resulting in bodily injury or damage to the computer.

1 Follow the procedures in "Before You Begin" on page 85.

2 Loosen the captive screw securing the stand to the base of the computer.

3 Gently slide the stand back, towards the rear of the computer, then pull the stand away from the computer to remove it.

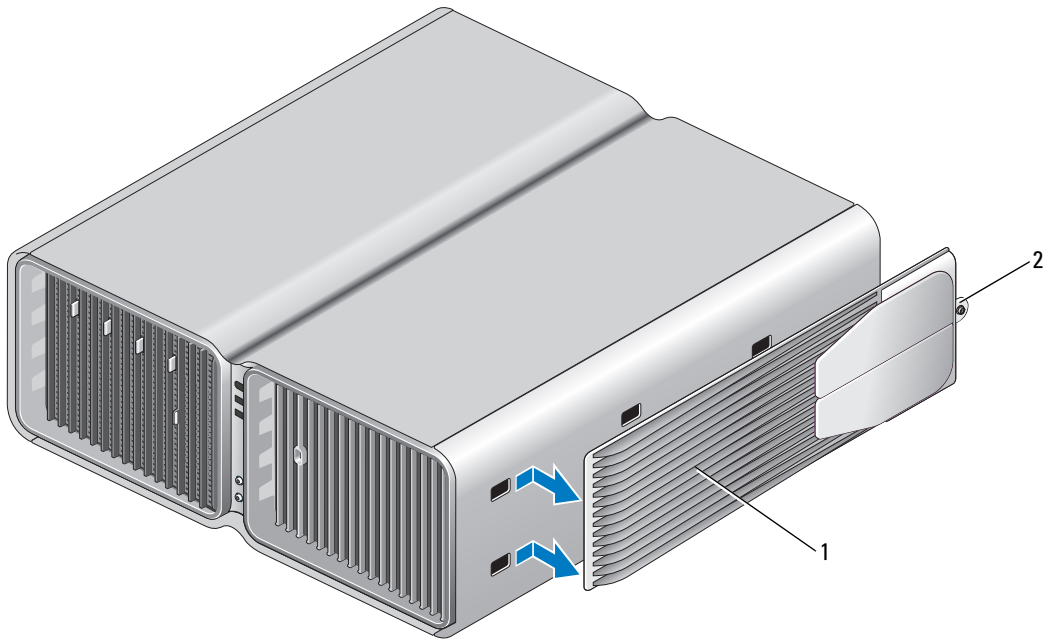

1 computer stand

2 captive screw

Replacing the Computer Cover

⚠ CAUTION: Before you begin any of the procedures in this section, follow the safety instructions in the *Product Information Guide*.

⚠ CAUTION: Your computer is heavy and can be difficult to maneuver. Seek assistance before attempting to lift, move, or tilt the computer and always lift correctly to avoid injury; avoid bending over while lifting.

⚠ CAUTION: The computer stand should be installed at all times to ensure maximum system stability. Failure to install the stand could result in the computer tipping over, potentially resulting in bodily injury or damage to the computer.

➡ NOTICE: To avoid electrostatic discharge and damage to internal components, ground yourself by using a wrist grounding strap or by periodically touching an unpainted metal surface on the computer chassis.

- 1 Ensure that all cables are connected, and fold cables out of the way.
- 2 Ensure that no tools or extra parts are left inside the computer.
- 3 Pivot the cover down and into position.

- 4 Press down on the cover until it clicks into place.

 **NOTE:** The computer cover should easily snap into place; however, if necessary, pull back on the cover release latch until the cover is completely closed, then slide the release latch forward to secure the cover.

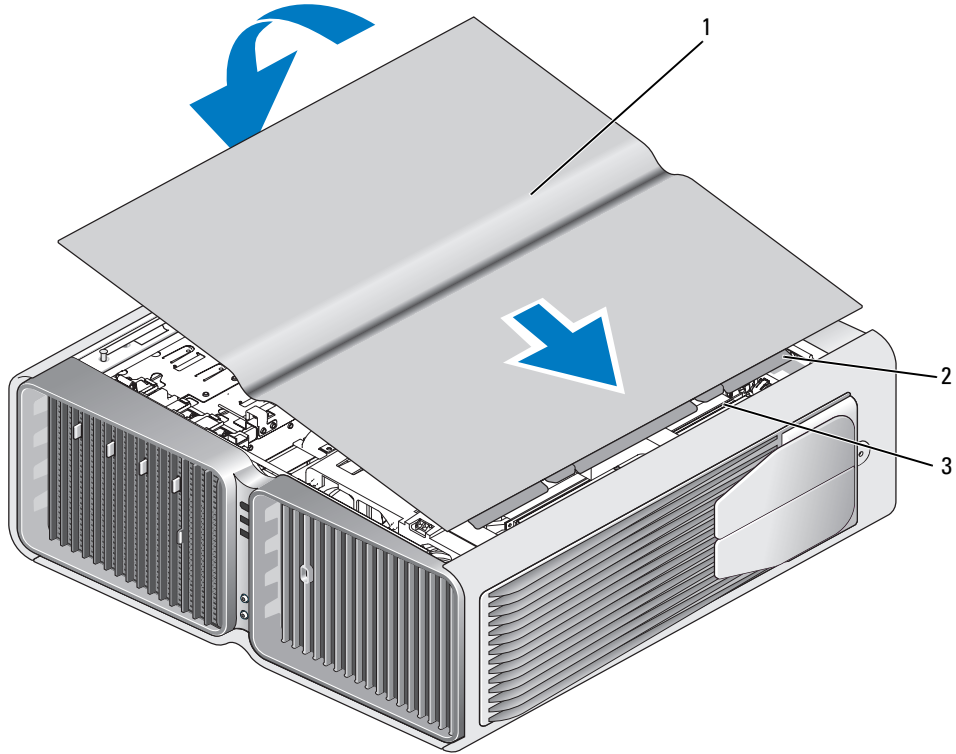

1 computer cover

2 cover hinge tabs

3 hinge slots

- 5 Carefully, lift the rear of the computer and slide the stabilizing feet outward into the open position.

- 6 With the help of an assistant, carefully set the computer upright.

 **NOTICE:** To connect a network cable, first plug the cable into the network port or device and then plug it into the computer.

- 7 Connect your computer and devices to electrical outlets, and turn them on.

Appendix

Specifications

Processor	
Processor type	Intel® Core™ 2 Duo (dual-core processor) Intel® Core™ 2 Extreme (dual-core processor) Intel® Core™ 2 Extreme (quad-core processor)
Cache	at least 1 MB
Memory	
Type	800, and 667-MHz DDR2 unbuffered SDRAM; SLI memory
Memory connectors	four
Memory capacities	512 MB, 1 GB, or 2 GB non-ECC
Minimum memory	1 GB
Maximum memory	8 GB NOTE: See "Addressing Memory Configurations" on page 91 to verify the amount of memory available to the operating system.
Computer Information	
Chipset	NVIDIA nForce 680i SLI
Northbridge	C55XE
Southbridge	MCP55PXE
DMA channels	five
Interrupt levels	24
BIOS chip (NVRAM)	4 Mb
NIC	integrated network interface capable of 10/100/1000 communication
Video	
Type	PCI Express

Audio

Type	HDA 7.1 channel
------	-----------------

Expansion Bus

Bus type	PCI Express x1 and x16 PCI 32-bit
----------	--------------------------------------

PCI (SLOT3, SLOT5, SLOT6)

Connector	three
Connector size	124 pins
Connector data width (maximum)	32 bits
Bus speed	33 MHz

PCI Express (SLOT1)

NOTE: If a graphics card is installed in each of the PCI Express x16 card slots in the dual-graphics configuration, the PCI Express x1 card slot is not accessible for use.

Connector	one x1
Connector size	36 pins
Connector data width (maximum)	1 PCI Express lane
Bus throughput	x1 slot bidirectional speed — 2.5 Gbps

PCI Express (SLOT7)

Connector	one x16
Connector size	164 pins
Connector data width (maximum)	8 PCI Express lanes
Bus throughput	x16 slot bidirectional speed — 20 Gbps

PCI Express (SLOT2, SLOT4)

Connector	two x16
Connector size	164 pins
Connector data width (maximum)	16 PCI Express lanes
Bus throughput	x16 slot bidirectional speed — 40 Gbps

Drives	
Available devices	Serial ATA drive, floppy drive, memory devices, Blu-ray™ Disc drive, DVD drive, DVD-RW drive, CD-RW/DVD combo drive, and media card reader
Externally accessible:	two 3.5-inch drive bays four 5.25-inch drive bays
Internally accessible:	four 3.5-inch drive bays for hard drives

Connectors	
External connectors:	
IEEE 1394	front and back-panel 6-pin serial connectors
Network adapter	RJ45 connector
PS/2 (keyboard and mouse)	two 6-pin mini-DIN
USB	two front-panel, six back-panel, and two internal USB 2.0-compliant connectors
System board connectors:	
IDE drive	one 40-pin connector
Serial ATA	six 7-pin connectors
Floppy drive	34-pin connector
Fan	three 5-pin connectors
Liquid cooling (optional)	one 12-pin connector
PCI	three 124-pin connectors
PCI Express x1	36-pin connector
PCI Express x16 (SLOT7); card length up to 17.8 cm (7 inches only)	164-pin connector
PCI Express x16	three 164-pin connectors

Controls and Lights	
Power control	push button
Power light	green light — Blinking green in sleep state; solid green for power-on state. amber light — Blinking amber indicates a problem with an installed device; solid amber indicates an internal power problem.
Hard-drive access light	green

Controls and Lights (continued)

Network activity light (front panel)	solid green indicates network connection
Link integrity light (on integrated network adapter)	green light — A good connection exists between a 10-Mbps network and the computer. orange light — A good connection exists between a 100-Mbps network and the computer. yellow light — A good connection exists between a 1-GB (1000-Mbps) network and the computer. off (no light) — The computer is not detecting a physical connection to the network.
Activity light (on integrated network adapter)	yellow blinking light when there is activity on the network; if there is not any network activity, the light will be off
Diagnostic lights	four lights on the front panel (see "Diagnostic Lights" on page 66)
Standby power light	AUXPWR on the system board
Front panel LEDs	eight multi-colored LEDs provide illumination for the front of the computer NOTE: The color of the front panel LEDs can be adjusted in system setup (see "System Setup" on page 168).
Back panel LEDs	two multi-colored lights provide illumination for the I/O panel on the back of the computer NOTE: The color of the back panel LEDs can be adjusted in system setup (see "System Setup" on page 168).

Power

DC power supply:	 CAUTION: To reduce the risk of fire, electric shock, or injury, do not overload an electrical outlet, power strip, or convenience receptacle. The total ampere rating of all products plugged into an electrical outlet, power strip, or other receptacle should not exceed 80 percent of the branch circuit rating.
Wattage	750 W or 1 KW
Voltage (see the safety instructions located in the <i>Product Information Guide</i>)	auto-sensing power supply—90 V to 265 V at 50/60 Hz
Backup battery	3-V CR2032 lithium coin cell

Physical

Height

Without stand	55.5 cm (21.9 inches)
With stand	57.2 cm (22.5 inches)

Width

Without stand	21.9 cm (8.6 inches)
With stand	35.6 cm (14.0 inches)

Depth

59.4 cm (23.4 inches)

Weight

Typical configuration	21.7 kg (47.8 lb)
Maximum configuration	25.6 kg (56.4 lb)

Environmental

Temperature:

Operating	10° to 35°C (50° to 95°F)
Storage	-40° to 65°C (-40° to 149°F)

Relative humidity

20% to 80% (noncondensing)

Maximum vibration:

Operating	0.25 G at 3 to 200 Hz at 0.5 octave/min
Storage	0.5 G at 3 to 200 Hz at 1 octave/min

Maximum shock:

Operating	bottom half-sine pulse with a change in velocity of 20 inches/sec (50.8 cm/sec)
Storage	27-G faired square wave with a velocity change of 200 inches/sec (508 cm/sec)

Altitude:

Operating	-15.2 to 3048 m (-50 to 10,000 ft)
Storage	-15.2 to 10,668 m (-50 to 35,000 ft)

System Setup

Overview

Use system setup as follows:

- To change the system configuration information after you add, change, or remove any hardware in your computer
- To set or change a user-selectable option such as the user password
- To read the current amount of memory or set the type of hard drive installed

Before you use system setup, it is recommended that you write down the system setup screen information for future reference.



NOTICE: Do not change the settings in system setup unless you are an expert computer user. Certain changes can cause your computer to work incorrectly.

Entering System Setup

- 1 Turn on (or restart) your computer.
- 2 When the DELL logo appears, press <F2> immediately.



NOTE: Keyboard failure may result when a key on the keyboard is held down for extended periods of time. To avoid possible keyboard failure, press and release <F2> in even intervals until the system setup screen appears.

If you wait too long and the operating system logo appears, continue to wait until you see the Microsoft® Windows® desktop, then shut down your computer and try again.

System Setup Screens

The system setup screen displays current or changeable configuration information for your computer. Information on the screen is divided into three areas: the options list, the active options field, and key functions.

<p>Options List — This field appears on the left side of the system setup window. The field is a scrollable list containing features that define the configuration of your computer, including installed hardware, power conservation, and security features.</p> <p>Scroll up and down the list with the up- and down-arrow keys. As an option is highlighted, the Options Field displays more information about that option and the option's current and available settings.</p>	<p>Options Field — This field appears on the right side of the system setup window and contains information about each option listed in the Options List. In this field you can view information about your computer and make changes to your current settings.</p> <p>Press the left- and right-arrow keys to highlight an option. Press <Enter> to make that selection active and return to the Options List.</p> <p>NOTE: Not all settings listed in the Options Field are changeable.</p> <hr/> <p>Key Functions — This field appears below the Options Field and lists keys and their functions within the active system setup field.</p>
--	--

System Setup Options

 **NOTE:** Depending on your computer and installed devices, the items listed in this section may not appear, or may not appear exactly as listed.

System	
System Info	Lists system information, such as the computer name, the BIOS version number and date, the system service tag, express service code and asset tag, and other system-specific information.
Processor Info	Identifies the processor type, clock speed, bus speed, L2 cache, L3 cache, ID, and whether the processor is multiple core capable, supports Hyper-Threading and supports 64-bit technology.
Memory Info	Identifies the memory type, speed, and channel mode (dual or single) by DIMM slot location.
PCI Info	Indicates the expansion card type by slot location.
Date/Time	Displays current date and time settings.

Boot Sequence	<p>The computer attempts to boot from the sequence of devices specified in this list.</p> <p>NOTE: If you insert a boot device and restart the computer, this option appears in the system setup menu. To boot from a USB memory device, for example, select the USB device and move it so that it becomes the first device in the boot sequence.</p>
---------------	--

Drives

Diskette Drive (Internal default)	<p>Enables and disables the floppy drive attached to the DSKT connector on the system board and sets read permissions for the drive.</p> <ul style="list-style-type: none"> • Off — All floppy drives are disabled. • USB — USB floppy drives are enabled • Internal — The integrated floppy drive is enabled. • Read Only — The integrated floppy drive is enabled with read-only access. <p>NOTE: Operating systems with USB support will recognize USB floppy drives regardless of this setting.</p>
--------------------------------------	--

SATA Drives 0 through 5 (On default)	<p>Enables or disables drives attached to the SATA connectors on the system board.</p> <ul style="list-style-type: none"> • Off — A device attached to the interface is not usable. • On — A device attached to the interface is usable. • RAID On - A device attached to the interface is configured for RAID (see "About Your RAID Configuration" on page 29).
---	--

PATA Drives 0 through 1 (On default)	<p>Enables or disables drives attached to the ATA connectors on the system board, and lists the controller details.</p> <ul style="list-style-type: none"> • Off — A device attached to the interface is not usable. • On — A device attached to the interface is usable.
---	---

SMART Reporting (Off default)	<p>Determines whether hard-drive errors for internal drives are reported during system startup.</p> <ul style="list-style-type: none"> • Off — Errors are not reported. • On — Errors are reported.
----------------------------------	---

Onboard Devices

Integrated NIC (On default)	<p>Enables or disables the integrated network interface controller (NIC).</p> <ul style="list-style-type: none"> • Off — The integrated NIC is disabled. • On — The integrated NIC is enabled. • On w/PXE — The integrated NIC is on (with PXE enabled). <p>NOTE: PXE is required only if you are booting to an operating system located on another computer. If a boot routine is not available from the remote system, the computer attempts to boot from the next device listed in the boot sequence.</p>
--------------------------------	---

Integrated Audio (On default)	Enables or disables the onboard audio controller. <ul style="list-style-type: none"> • Off — Integrated audio is disabled. • On — Integrated audio is enabled.
USB Controller (On default)	Enables or disables the internal USB controller. <ul style="list-style-type: none"> • Off — The USB controller is disabled. • On — The USB controller is enabled. • No Boot — The USB controller is enabled; however, the BIOS will not recognize USB storage devices. <p>NOTE: Operating systems with USB support will recognize USB storage devices regardless of the No Boot setting.</p>
1394 Controller (On default)	Enables or disables the integrated IEEE 1394 controller. <ul style="list-style-type: none"> • Off — The 1394 controller is disabled. • On — The 1394 controller is enabled.
PS/2 Mouse Port (On default)	Enables or disables the onboard PS/2-compatible mouse controller. <ul style="list-style-type: none"> • Off — The PS/2 legacy mouse port is disabled. • On — The PS/2 legacy mouse port is enabled.
LED Control	
Front Upper LED	Adjusts the color of the upper front panel LEDs (see "Front and Back View of the Computer" on page 13).
Front Lower LED	Adjusts the color of the lower front panel LEDs (see "Front and Back View of the Computer" on page 13).
Rear Panel LED	Adjusts the color of the rear panel LEDs (see "Front and Back View of the Computer" on page 13).
LED Intensity	Adjusts the intensity for the color of the upper and lower front panel LEDs and the rear panel LEDs.
Performance	
Multiple CPU Core (On default)	Specifies whether the processor has more than one core enabled. <ul style="list-style-type: none"> • Off — Multiple CPU core technology is disabled. • On — Multiple CPU core technology is enabled. <p>NOTE: The performance of some applications may improve with an additional core enabled.</p>

Advanced	<p>Displays processor type and current BIOS settings for processor clock speed, processor multiplier, front side bus (FSB) clock, and CPU core voltage. These settings may have been set by performance tuning applications or may change depending on settings in performance applications that you have installed.</p> <p>For systems with Intel Extreme processors, the following fields are adjustable through the BIOS:</p> <ul style="list-style-type: none"> • Processor Clock Speed: Adjusts the multiplier of the processor. For processors that cannot be overclocked, this field reports the current settings and cannot be changed. • Performance Application Support: Enables software applications to display and modify key system parameters to tune system performance. These applications are not installed or supported by Dell. The default is Off. <p>NOTE: To enable overclocking of other system components, you first need to enable the Performance Application Support option in BIOS and then download an application like NVIDIA nTune version 5.0 or higher.</p> <p>NOTE: Pressing <Alt><F> returns your system to the factory defaults including RAID settings.</p>
SpeedStep (Off default)	<p>Specifies whether Enhanced Intel SpeedStep® technology is enabled for all supported processors in the system.</p> <ul style="list-style-type: none"> • Off — Disable Enhanced SpeedStep technology • On — Enable Enhanced SpeedStep technology
Virtualization (Off default)	<p>Specifies whether a virtual machine monitor (VMM) can utilize the additional hardware capabilities provided by Intel Virtualization Technology</p> <ul style="list-style-type: none"> • Off — Disable Virtualization Technology • On — Enable Virtualization Technology
HDD Acoustic Mode (Bypass default)	<p>Determines the acoustic mode at which the hard drive operates.</p> <ul style="list-style-type: none"> • Bypass — Do nothing (needed for older drives). • Quiet — The hard drive operates at a slower, but quieter speed. • Suggested — Allow the hard drive manufacturer to select the mode. • Performance — The hard drive operates at a faster, but possibly noisier speed. <p>NOTE: Switching to performance mode may cause an increase in noise produced by the drive, but does not affect the drive's performance.</p> <p>NOTE: Changing the acoustics setting does not alter your hard drive image.</p>
Security	
Admin Password (Not Set default)	Used to prohibit an unauthorized user from changing any configuration settings in the system setup.
System Password (Not Set default)	Used to prohibit an unauthorized user from booting to the operating system.

Password Changes (Unlocked default)	This option locks the system password field with the administrator (admin) password. NOTE: When the system password field is locked, you can no longer disable password security by pressing <Ctrl><Enter> when the computer starts.
Execute Disable (On default)	Enables or disables Execute Disable Memory Protection technology. <ul style="list-style-type: none"> • Off — Execute Disable Memory Protection technology is disabled. • On — Execute Disable Memory Protection technology is enabled.
Power Management	
AC Recovery (Off default)	Specifies how the computer will behave when AC power is restored after an AC power loss. <ul style="list-style-type: none"> • Off — The system stays off after AC power is restored. • On — The system powers on after AC power is restored. • Last — The system returns to the previous state after AC power is restored.
Auto Power On (Off default)	Disables or selects when to automatically turn on the computer. <ul style="list-style-type: none"> • Off — Do not use the Auto Power Time. • Everyday — Turn the computer on every day at the time set in Auto Power Time. • Weekdays — Turn the computer on Monday through Friday at the time set in Auto Power Time. NOTE: This feature does not work if you turn off your computer using a power strip or surge protector.
Auto Power Time	Specifies the time to automatically turn on the computer. Change the time to automatically turn on the computer by pressing the up- or down-arrow key to increase or decrease the numbers, or type the numbers in the appropriate time field. NOTE: This feature does not work if you turn off your computer using a power strip or surge protector.
Low Power Mode (Off default)	Specifies how aggressive the system is at conserving power while in hibernate mode or turned off. <ul style="list-style-type: none"> • Off — Add more functionality. • On — Conserve more power.
Suspend Mode (S3 default)	Specifies the power management suspend mode. <ul style="list-style-type: none"> • S1 — The computer resumes more quickly from sleep mode. • S3 — The computer conserves more power when not in use (system memory remains active).

Maintenance	
Service Tag	Displays the system service tag.
SERR Message (On default)	Controls the SERR message mechanism. Some graphics cards require that the SERR Message mechanism be disabled. <ul style="list-style-type: none"> • Off — Do not use the SERR message mechanism. • On — Use the SERR message mechanism.
Load Defaults	This setting restores the computer's factory-installed default settings. <ul style="list-style-type: none"> • Cancel — Do not restore factory-installed default settings. • Continue — Restore factory-installed default settings.
Event Log	Displays the system event log. <ul style="list-style-type: none"> • Mark all entries — Mark all event log entries as read (R). • Clear log — Clear all event log entries. <p>NOTE: Once an event log entry is marked as read (R) that entry cannot be marked as unread (U).</p>
POST Behavior	
Fastboot (On default)	Enables or disables the option to speed up the boot process by skipping some compatibility tests. <ul style="list-style-type: none"> • Off — Do not skip any steps in the boot process. • On — Boot quickly.
Numlock Key (On default)	Enables or disables the numerical and mathematical features of the rightmost bank of keys on the keyboard. <ul style="list-style-type: none"> • Off — Right keypad keys function as arrows. • On — Right keypad keys function as numbers.
POST Hotkeys (Setup & Boot Menu default)	Specifies the function keys to display on the screen when the computer starts. <ul style="list-style-type: none"> • Setup & Boot Menu — Display both messages (F2=Setup and F12=Boot Menu). • Setup — Display the setup message only (F2=Setup). • Boot Menu — Display the Quickboot message only (F12=Boot Menu). • None — Neither message is displayed.
Keyboard Errors (Report default)	Enables or disables keyboard error reporting when the computer starts. <ul style="list-style-type: none"> • Report — Display any keyboard errors. • Do not report — Do not display any keyboard errors.

Boot Sequence

This feature allows you to change the boot sequence for the bootable devices installed on your computer.

Option Settings

- **Diskette Drive** — The computer attempts to boot from the floppy drive. If the floppy disk in the drive is not bootable, if no floppy disk is in the drive, or if there is no floppy drive installed in the computer, the computer attempts to boot from the next bootable device in the boot sequence.
- **Hard Drive** — The computer attempts to boot from the primary hard drive. If no operating system is on the drive, the computer attempts to boot from the next bootable device in the boot sequence.
- **CD Drive** — The computer attempts to boot from the CD drive. If no CD is in the drive, or if the CD has no operating system, the computer attempts to boot from the next bootable device in the boot sequence.
- **USB Flash Device** — Insert the memory device into a USB port and restart the computer. When **F12 = Boot Menu** appears in the upper-right corner of the screen, press <F12>. The BIOS detects the device and adds the USB flash option to the boot menu.



NOTE: To boot to a USB device, the device must be bootable. To make sure that your device is bootable, check the device documentation.



NOTE: An error message is generated only after the computer attempts to boot from every device in the boot sequence and no operating system is found.

Changing Boot Sequence for the Current Boot

You can use this feature, for example, to tell the computer to boot from the CD drive so that you can run the Dell Diagnostics on the *Drivers and Utilities* media, but you want the computer to boot from the hard drive when the diagnostic tests are complete. You can also use this feature to restart your computer to a USB device such as a floppy drive, memory key, or CD-RW drive.



NOTE: If you are booting to a USB floppy drive, you must first set the floppy drive to **OFF** in system setup (see "System Setup" on page 168).

- 1 If you are booting to a USB device, connect the USB device to a USB connector (see "Back View" on page 16).
- 2 Turn on (or restart) your computer.
- 3 When the **DELL** logo appears, press <F12> immediately.



NOTE: Keyboard failure may result when a key on the keyboard is held down for extended periods of time. To avoid possible keyboard failure, press and release <F12> in even intervals until the **Boot Device Menu** appears.

If you wait too long and the operating system logo appears, continue to wait until you see the Microsoft Windows desktop, then shut down your computer and try again.

- 4 At the **Boot Device Menu**, use the up- and down-arrow keys or press the appropriate number on the keyboard to highlight the device that is to be used for the current boot only, and then press <Enter>. For example, if you are booting to a USB memory key, highlight **USB Flash Device** and press <Enter>.

 **NOTE:** To boot to a USB device, the device must be bootable. To make sure that your device is bootable, check the device documentation.

Changing Boot Sequence for Future Boots

- 1 Enter system setup (see "Entering System Setup" on page 168).
- 2 Use the arrow keys to highlight the **Boot Sequence** menu option and press <Enter> to access the menu.

 **NOTE:** Write down your current boot sequence in case you want to restore it.

- 3 Press the up- and down-arrow keys to move through the list of devices.
- 4 Press the spacebar to enable or disable a device (enabled devices have a checkmark).
- 5 Press plus (+) or minus (-) to move a selected device up or down the list.

Clearing Forgotten Passwords

 **CAUTION:** Before you begin any of the procedures in this section, follow the safety instructions in the *Product Information Guide*.

 **NOTICE:** This process erases both the system and setup passwords

- 1 Follow the procedures in "Before You Begin" on page 85.
- 2 Remove the computer cover (see "Removing the Computer Cover" on page 86).

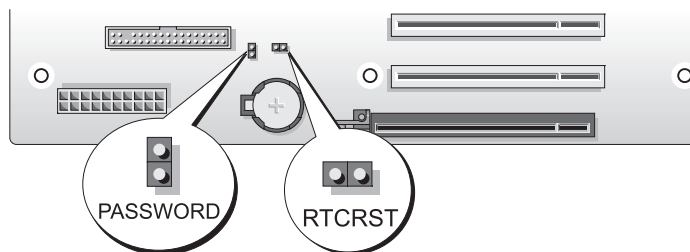





- 3 Locate the 2-pin password jumper (PASSWORD) on the system board (see "System Board Components" on page 89), then remove the jumper plug and set the plug aside.
- 4 Close the computer cover.
- 5 Connect your keyboard and mouse, then connect your computer and monitor to electrical outlets and turn them on.

- 6 After the Microsoft® Windows® desktop appears on your computer, turn the computer off:
 - a Save and close all open files and exit all open programs.
 - b Shut down the operating system:
 - In Windows XP, click **Start**→**Turn Off Computer**→**Turn off**.
 - In Windows Vista, click **Start** , click the arrow in the lower-right corner of the Start menu as shown below, and then click **Shut Down**.



The computer turns off after the operating system shutdown process is complete.



-  **NOTE:** Ensure that the computer is off and not in a power management mode. If you cannot shut down the computer using the operating system, press and hold the power button for 4 seconds.
- 7 Disconnect the keyboard and mouse, then disconnect the computer and monitor from their electrical outlets.
 - 8 Press the power button on the computer to ground the system board.
 - 9 Open the computer cover (see "Removing the Computer Cover" on page 86).
-  **NOTICE:** The password jumper plug must be reinstalled on the password jumper pins in order to enable the password feature.
- 10 Locate the 2-pin password jumper on the system board (see "System Board Components" on page 89), and then reinstall the jumper plug to enable the password feature.
 - 11 Replace the computer cover (see "Replacing the Computer Cover" on page 160).
-  **NOTICE:** To connect a network cable, first plug the cable into the network wall jack and then plug it into the computer.
- 12 Connect your computer and devices to electrical outlets, and then turn them on.
-  **NOTE:** In system setup (see "Entering System Setup" on page 168), both system and administrator password options appear as **Not Set**. The password feature is enabled but a password is not assigned.

Clearing CMOS Settings

 **CAUTION:** Before you begin any of the procedures in this section, follow the safety instructions in the *Product Information Guide*.

 **NOTE:** This procedure does not clear or reset system and setup passwords.

- 1 Follow the procedures in "Before You Begin" on page 85.
- 2 Remove the computer cover (see "Removing the Computer Cover" on page 86).
- 3 Locate the password (PASSWORD) and CMOS (RTCRST) jumpers on the system board (see "System Board Components" on page 89).

- 4 Remove the password jumper plug, then place the plug on the CMOS jumper pins and wait approximately 5 seconds.
-  **NOTICE:** The password jumper plug must be reinstalled on the password jumper pins in order to enable the password feature.
- 5 Remove the jumper plug from the CMOS jumper pins, and then reinstall the plug on the password jumper pins to enable the password feature.
- 6 Close the computer cover (see "Replacing the Computer Cover" on page 160).
-  **NOTICE:** To connect a network cable, first plug the cable into the network wall jack and then plug it into the computer.
- 7 Connect your computer and devices to electrical outlets, and then turn them on.

Cleaning Your Computer

 **CAUTION:** Before you begin any of the procedures in this section, follow the safety instructions in the *Product Information Guide*.

Computer, Keyboard, and Monitor

 **CAUTION:** Before you clean your computer, disconnect the computer from the electrical outlet. Clean your computer with a soft cloth dampened with water. Do not use liquid or aerosol cleaners, which may contain flammable substances.

- Use a vacuum cleaner with a brush attachment to gently remove dust from the slots and holes on your computer and from between the keys on the keyboard.

 **NOTICE:** Do not wipe the display screen with any soap or alcohol solution. Doing so may damage the antiglare coating.

- To clean your monitor screen, lightly dampen a soft, clean cloth with water. If possible, use a special screen-cleaning tissue or solution suitable for the monitor's antistatic coating.
- Wipe the keyboard, computer, and plastic part of the monitor with a soft cleaning cloth moistened with water.

Do not soak the cloth or let water drip inside your computer or keyboard.

Mouse

If your screen cursor skips or moves abnormally, clean the mouse. To clean a non-optical mouse:

- 1 Turn the retainer ring on the underside of your mouse counterclockwise, and then remove the ball.
- 2 Wipe the ball with a clean, lint-free cloth.
- 3 Blow carefully into the ball cage to dislodge dust and lint.
- 4 If the rollers inside the ball cage are dirty, clean the rollers with a cotton swab moistened lightly with isopropyl alcohol.

- 5 Recenter the rollers in their channels if they are misaligned. Ensure that fluff from the swab is not left on the rollers.
- 6 Replace the ball and retainer ring, and turn the retainer ring clockwise until it clicks into place.

Floppy Drive

 **NOTICE:** Do not attempt to clean drive heads with a swab. The heads may become misaligned and prevent the drive from operating.

Clean your floppy drive using a commercially available cleaning kit. These kits contain pretreated floppy disks to remove contaminants that accumulate during normal operation.

CDs and DVDs

 **NOTICE:** Always use compressed air to clean the lens in the optical drive, and follow the instructions that come with the compressed air. Never touch the lens in the drive.

If you notice problems, such as skipping, with the playback quality of your discs, try cleaning the discs.

- 1 Hold the disc by its outer edge. You can also touch the inside edge of the center hole.

 **NOTICE:** To prevent damaging the surface, do not wipe in a circular motion around the disc.

- 2 With a soft, lint-free cloth, gently wipe the bottom of the disc (the unlabeled side) in a straight line from the center to the outer edge of the disc.

For stubborn dirt, try using water or a diluted solution of water and mild soap. You can also purchase commercial products that clean discs and provide some protection from dust, fingerprints, and scratches. Cleaning products for CDs are safe to use on DVDs.

FCC Notices (U.S. Only)

Most Dell computer systems are classified by the Federal Communications Commission (FCC) as Class B digital devices. To determine which classification applies to your computer system, examine all FCC registration labels located on the bottom, side, or back panel of your computer, on card-mounting brackets, and on the cards themselves. If any one of the labels carries a Class A rating, your entire system is considered to be a Class A digital device. If *all* labels carry an FCC Class B rating as distinguished by either an FCC ID number or the FCC logo, (**FC**), your system is considered to be a Class B digital device.

Once you have determined your system's FCC classification, read the appropriate FCC notice. Note that FCC regulations provide that changes or modifications not expressly approved by Dell could void your authority to operate this equipment.

This device complies with Part 15 of the FCC Rules. Operation is subject to the following two conditions:

- 1 This device may not cause harmful interference.
- 2 This device must accept any interference received, including interference that may cause undesired operation.

Class A

This equipment has been tested and found to comply with the limits for a Class A digital device pursuant to Part 15 of the FCC Rules. These limits are designed to provide reasonable protection against harmful interference when the equipment is operated in a commercial environment. This equipment generates, uses, and can radiate radio frequency energy and, if not installed and used in accordance with the manufacturer's instruction manual, may cause harmful interference with radio communications. Operation of this equipment in a residential area is likely to cause harmful interference, in which case you will be required to correct the interference at your own expense.

Class B

This equipment has been tested and found to comply with the limits for a Class B digital device pursuant to Part 15 of the FCC Rules. These limits are designed to provide reasonable protection against harmful interference in a residential installation. This equipment generates, uses, and can radiate radio frequency energy and, if not installed and used in accordance with the manufacturer's instruction manual, may cause interference with radio communications. However, there is no guarantee that interference will not occur in a particular installation. If this equipment does cause harmful interference to radio or television reception, which can be determined by turning the equipment off and on, you are encouraged to try to correct the interference by one or more of the following measures:

- Reorient or relocate the receiving antenna.
- Increase the separation between the equipment and the receiver.
- Connect the equipment into an outlet on a circuit different from that to which the receiver is connected.
- Consult the dealer or an experienced radio/television technician for help.

FCC Identification Information

The following information is provided on the device or devices covered in this document in compliance with FCC regulations:

- Product name: Dell™ XPS™ 720
- Model number: DCDO

Company name:

Dell Inc.
One Dell Way
Round Rock, Texas 78682 USA
512-338-4400

Contacting Dell

You can contact Dell through the Internet and by phone:

- For support through the web, go to support.dell.com.
- For worldwide support through the web, use the **Choose A Country/Region** menu near the bottom of the page, or see the web addresses listed in the following table.
- For support by e-mail, see the e-mail addresses listed in the following table.



NOTE: Toll-free numbers are for use within the country for which they are listed.



NOTE: In certain countries, support specific to Dell™ XPS™ computers is available at a separate telephone number listed for participating countries. If you do not see a telephone number listed that is specific for XPS computers, you may contact Dell through the support number listed and your call will be routed appropriately.

- For support by phone, use the phone numbers and codes provided in the following table. If you need assistance in determining which codes to use, contact a local or an international operator.



NOTE: The contact information provided was deemed correct at the time that this document went to print and is subject to change.

Country (City) International Access Code Country Code City Code	Service Type	Area Codes, Local Numbers, and Toll-Free Numbers Web and E-mail Address
Anguilla	Online Support	www.dell.com/ai
	E-mail Address	la-techsupport@dell.com
	Technical Support, Customer Service, Sales	toll-free: 800-335-0031
Antigua and Barbuda	Online Support	www.dell.com.ag
		la-techsupport@dell.com
	Technical Support, Customer Service, Sales	1-800-805-5924
Aomen Country Code: 853	Technical Support	toll-free: 0800-105
	Customer Service (Xiamen, China)	34 160 910
	Transaction Sales (Xiamen, China)	29 693 115

Country (City) International Access Code Country Code City Code	Service Type	Area Codes, Local Numbers, and Toll-Free Numbers Web and E-mail Address
Argentina (Buenos Aires) International Access Code: 00 Country Code: 54 City Code: 11	Online Support	www.dell.com.ar
	E-mail for Desktops and Portables	la-techsupport@dell.com
	E-mail for Servers and EMC® Storage Products	la_enterprise@dell.com
	Customer Service	toll-free: 0-800-444-0730
	Technical Support – Dell PowerApp™, Dell PowerEdge™, Dell PowerConnect™, and Dell PowerVault™	toll-free: 0-800-222-0154
	Technical Support Services Sales	toll-free: 0-800-444-0724 0-810-444-3355
Aruba	Online Support	www.dell.com.aw la-techsupport@dell.com
	Technical Support, Customer Service, Sales	toll-free: 800-1578
Australia (Sydney) International Access Code: 0011 Country Code: 61 City Code: 2	Online Support	support.ap.dell.com support.ap.dell.com/contactus
	Technical Support	
	Technical Support for XPS computers only	toll-free: 1300 790 877
	Home and Home Office	toll-free: 1300-655-533
	Medium and Large Business	toll-free: 1800-633-559
	Small Business, Education, Local Government	toll-free: 1800-060-889
Customer Service	toll-free: 1300-662-196	

Country (City) International Access Code Country Code City Code	Service Type	Area Codes, Local Numbers, and Toll-Free Numbers Web and E-mail Address
Austria (Vienna) International Access Code: 900 Country Code: 43 City Code: 1	Online Support	support.euro.dell.com tech_support_central_europe@dell.com
	Technical Support for XPS computers only	08 20 24 05 30 81
	Home/Small Business Sales	08 20 24 05 30 00
	Home/Small Business Fax	08 20 24 05 30 49
	Home/Small Business Customer Service	08 20 24 05 30 14
	Home/Small Business Support	08 20 24 05 30 17
	Preferred Accounts/Corporate Customer Service	08 20 24 05 30 16
	Preferred Accounts/Corporate Support Switchboard	08 20 24 05 30 17 08 20 24 05 30 00
Bahamas	Online Support	www.dell.com/bs la-techsupport@dell.com
	Technical Support, Customer Service, Sales	toll-free: 1-866-874-3038
Barbados	Online Support	www.dell.com/bb la-techsupport@dell.com
	Technical Support, Customer Service, Sales	1-800-534-3142
Belgium (Brussels) International Access Code: 00 Country Code: 32 City Code: 2	Online Support	support.euro.dell.com
	Technical Support for XPS computers only	02 481 92 96
	General Support	02 481 92 88
	General Support Fax	02 481 92 95
	Customer Service	02 713 15 65
	Corporate Sales	02 481 91 00
	Fax Switchboard	02 481 92 99 02 481 91 00
Bermuda	Online Support	www.dell.com/bm la-techsupport@dell.com
	Technical Support, Customer Service, Sales	1-877-890-0751
Bolivia	Online Support	www.dell.com/bo la-techsupport@dell.com
	Technical Support, Customer Service, Sales	toll-free: 800-10-0238

Country (City) International Access Code Country Code City Code	Service Type	Area Codes, Local Numbers, and Toll-Free Numbers Web and E-mail Address
Brazil	Online Support	www.dell.com/br
International Access Code: 00		BR_TechSupport@dell.com
Country Code: 55	Customer Service and Tech Support	0800 970 3355
City Code: 51	Technical Support Fax	51 2104 5470
	Customer Service Fax	51 2104 5480
	Sales	0800 970 3390
British Virgin Islands	Technical Support, Customer Service, Sales	toll-free: 1-866-278-6820
Brunei	Technical Support (Penang, Malaysia)	604 633 4966
Country Code: 673	Customer Service (Penang, Malaysia)	604 633 3101
		or toll-free: 801 1012
	Transaction Sales (Penang, Malaysia)	604 633 3101
		or toll-free: 801 1012

Country (City) International Access Code Country Code City Code	Service Type	Area Codes, Local Numbers, and Toll-Free Numbers Web and E-mail Address
Canada (North York, Ontario) International Access Code: 011	Online Order Status	www.dell.ca/ostatus
	Online Support	support.ca.dell.com
	AutoTech (automated Hardware and Warranty Support)	toll-free: 1-800-247-9362
	Customer Service	
	Home/Home Office	toll-free: 1-800-847-4096
	Small Business	toll-free: 1-800-906-3355
	Medium/Large Business, Government, Education	toll-free: 1-800-387-5757
	Hardware Warranty Phone Support	
	XPS Computers Only	toll-free: 1-866-398-8977
	Computers for Home/Home Office	toll-free: 1-800-847-4096
	Computers for Small/Medium/Large Business, Government	toll-free: 1-800-387-5757
	Printers, Projectors, Televisions, Handheld, Digital Jukebox, and Wireless	1-877-335-5767
	Sales	
	Home and Home Office Sales	toll-free: 1-800-999-3355
Small Business	toll-free: 1-800-387-5752	
Medium/Large Business, Government	toll-free: 1-800-387-5755	
Spare Parts and Extended Service	1 866 440 3355	
Cayman Islands	Online Support	la-techsupport@dell.com
	Technical Support, Customer Service, Sales	1-877-262-5415
Chile (Santiago) Country Code: 56 City Code: 2	Online Support	www.dell.com/cl
		la-techsupport@dell.com
	Sales and Customer Support	toll-free: 1230-020-3397 or 800-20-1385

Country (City) International Access Code Country Code City Code	Service Type	Area Codes, Local Numbers, and Toll-Free Numbers Web and E-mail Address
China (Xiamen) Country Code: 86 City Code: 592	Online Support	support.dell.com.cn
	Technical Support E-mail	support.dell.com.cn/email
	Customer Service E-mail	customer_cn@dell.com
	Technical Support Fax	592 818 1350
	Technical Support – XPS computers only	toll-free: 800 858 0540
	Technical Support – Dell™ Dimension™ and Dell Inspiron™	toll-free: 800 858 2969
	Technical Support – Dell OptiPlex™, Dell Latitude™, and Dell Precision™	toll-free: 800 858 0950
	Technical Support – Servers and Storage	toll-free: 800 858 0960
	Technical Support – Projectors, PDAs, Switches, Routers, etc.	toll-free: 800 858 2920
	Technical Support – Printers	toll-free: 800 858 2311
	Customer Service	toll-free: 800 858 2060
	Customer Service Fax	592 818 1308
	Home and Small Business	toll-free: 800 858 2222
	Preferred Accounts Division	toll-free: 800 858 2557
	Large Corporate Accounts GCP	toll-free: 800 858 2055
	Large Corporate Accounts Key Accounts	toll-free: 800 858 2628
	Large Corporate Accounts North	toll-free: 800 858 2999
	Large Corporate Accounts North Government and Education	toll-free: 800 858 2955
	Large Corporate Accounts East	toll-free: 800 858 2020
	Large Corporate Accounts East Government and Education	toll-free: 800 858 2669
Large Corporate Accounts Queue Team	toll-free: 800 858 2572	
Large Corporate Accounts South	toll-free: 800 858 2355	
Large Corporate Accounts West	toll-free: 800 858 2811	
Large Corporate Accounts Spare Parts	toll-free: 800 858 2621	
Colombia	Online Support	www.dell.com/co la-techsupport@dell.com
	Technical Support, Customer Service, Sales	01-800-915-4755

Country (City) International Access Code Country Code City Code	Service Type	Area Codes, Local Numbers, and Toll-Free Numbers Web and E-mail Address
Costa Rica	Online Support	www.dell.com/cr la-techsupport@dell.com
	Technical Support, Customer Service, Sales	0800-012-0231
Czech Republic (Prague) International Access Code: 00 Country Code: 420	Online Support	support.euro.dell.com czech_dell@dell.com
	Technical Support	22537 2727
	Customer Service	22537 2707
	Fax	22537 2714
	Technical Fax	22537 2728
	Switchboard	22537 2711
Denmark (Copenhagen) International Access Code: 00 Country Code: 45	Online Support	support.euro.dell.com
	Technical Support for XPS computers only	7010 0074
	Technical Support	7023 0182
	Customer Service – Relational	7023 0184
	Home/Small Business Customer Service	3287 5505
	Switchboard – Relational	3287 1200
	Switchboard Fax – Relational	3287 1201
	Switchboard – Home/Small Business	3287 5000
Switchboard Fax – Home/Small Business	3287 5001	
Dominica	Online Support	www.dell.com/dm la-techsupport@dell.com
	Technical Support, Customer Service, Sales	toll-free: 1-866-278-6821
Dominican Republic	Online Support	www.dell.com/do la-techsupport@dell.com
	Technical Support, Customer Service, Sales	1-800-156-1588
Ecuador	Online Support	www.dell.com/ec la-techsupport@dell.com
	Technical Support, Customer Service, Sales (calling from Quito)	toll-free: 999-119-877-655-3355
	Technical Support, Customer Service, Sales (calling from Guayaquil)	toll-free: 1800-999-119-877-655-3355

Country (City) International Access Code Country Code City Code	Service Type	Area Codes, Local Numbers, and Toll-Free Numbers Web and E-mail Address
El Salvador	Online Support	www.dell.com/sv la-techsupport@dell.com
	Technical Support, Customer Service, Sales	800-6132
Finland (Helsinki) International Access Code: 990 Country Code: 358 City Code: 9	Online Support	support.euro.dell.com fi_support@dell.com
	Technical Support	0207 533 555
	Customer Service	0207 533 538
	Switchboard	0207 533 533
	Fax	0207 533 530
	Sales under 500 employees	0207 533 540
	Sales over 500 employees	0207 533 533
	France (Paris) (Montpellier) International Access Code: 00 Country Code: 33 City Codes: (1) (4)	Online Support
Technical Support for XPS computers only		0825 387 129
Home and Small Business		
Technical Support		0825 387 270
Customer Service		0825 823 833
Switchboard		0825 004 700
Switchboard (calls from outside of France)		04 99 75 40 00
Sales		0825 004 700
Fax		0825 004 701
Fax (calls from outside of France)		04 99 75 40 01
Corporate		
Technical Support		0825 004 719
Customer Service		0825 338 339
Switchboard		01 55 94 71 00
Sales		01 55 94 71 00
Fax		01 55 94 71 01

Country (City) International Access Code Country Code City Code	Service Type	Area Codes, Local Numbers, and Toll-Free Numbers Web and E-mail Address
Germany (Frankfurt) International Access Code: 00 Country Code: 49 City Code: 69	Online Support	support.euro.dell.com
		tech_support_central_europe@dell.com
	Technical Support for XPS computers only	069 9792 7222
	Technical Support	069 9792-7200
	Home/Small Business Customer Service	0180-5-224400
	Global Segment Customer Service	069 9792-7320
	Preferred Accounts Customer Service	069 9792-7320
	Large Accounts Customer Service	069 9792-7320
	Public Accounts Customer Service	069 9792-7320
	Switchboard	069 9792-7000
Greece International Access Code: 00 Country Code: 30	Online Support	support.euro.dell.com
	Technical Support	00800-44 14 95 18
	Gold Service Technical Support	00800-44 14 00 83
	Switchboard	2108129810
	Gold Service Switchboard	2108129811
	Sales	2108129800
	Fax	2108129812
Grenada	Online Support	www.dell.com/gd la-techsupport@dell.com
	Technical Support, Customer Service, Sales	toll-free: 1-866-540-3355
Guatemala	Online Support	www.dell.com/gt la-techsupport@dell.com
	Technical Support, Customer Service, Sales	1-800-999-0136
Guyana	Online Support	la-techsupport@dell.com
	Technical Support, Customer Service, Sales	toll-free: 1-877-270-4609

Country (City) International Access Code Country Code City Code	Service Type	Area Codes, Local Numbers, and Toll-Free Numbers Web and E-mail Address
Hong Kong	Online Support	support.ap.dell.com
International Access Code: 001		support.dell.com.cn/email
Country Code: 852	Technical Support – XPS computers only	00852-3416 6923
	Technical Support – Dimension and Inspiron	00852-2969 3188
	Technical Support – OptiPlex, Latitude, and Dell Precision	00852-2969 3191
	Technical Support – Servers and Storage	00852-2969 3196
	Technical Support – Projectors, PDAs, Switches, Routers, etc.	00852-3416 0906
	Customer Service	00852-3416 0910
	Large Corporate Accounts	00852-3416 0907
	Global Customer Programs	00852-3416 0908
	Medium Business Division	00852-3416 0912
	Home and Small Business Division	00852-2969 3105

Country (City) International Access Code Country Code City Code	Service Type	Area Codes, Local Numbers, and Toll-Free Numbers Web and E-mail Address
India	Online Support	support.ap.dell.com
	Portable and Desktop Support	
	Desktop Support E-mail	india_support_desktop@dell.com
	Portable Support E-mail	india_support_notebook@dell.com
	Phone Numbers	080-25068032 or 080-25068034 or your city STD code + 60003355 or toll-free: 1-800-425-8045
	Server Support	
	E-mail	india_support_Server@dell.com
	Phone Numbers	080-25068032 or 080-25068034 or your city STD code + 60003355 or toll-free: 1800 425 8045
	Gold Support Only	
	E-mail	eec_ap@dell.com
	Phone Numbers	080-25068033 or your city STD code + 60003355 or toll-free: 1-800-425-9045
	XPS Support Only	
	E-mail	Indiixps_AP@dell.com
	Phone Numbers	080-25068066 or toll-free: 1-800-425-2066
	Customer Service	
	Home and Small Business	India_care_HSB@dell.com toll-free: 1800-4254051
	Large Corporate Accounts	India_care_REL@dell.com toll-free: 1800-4252067
	Sales	
	Large Corporate Accounts	1600 33 8044
	Home and Small Business	1600 33 8046

Country (City) International Access Code Country Code City Code	Service Type	Area Codes, Local Numbers, and Toll-Free Numbers Web and E-mail Address
Ireland (Cherrywood)	Online Support	support.euro.dell.com
International Access Code: 00		dell_direct_support@dell.com
Country Code: 353	Technical Support	
City Code: 1	XPS computers only	1850 200 722
	Business computers	1850 543 543
	Home computers	1850 543 543
	At Home Support	1850 200 889
	Sales	
	Home	1850 333 200
	Small Business	1850 664 656
	Medium Business	1850 200 646
	Large Business	1850 200 646
	Sales E-mail	Dell_IRL_Outlet@dell.com
	Customer Service	
	Home and Small Business	01 204 4014
	Business (greater than 200 employees)	1850 200 982
	General	
	Fax/Sales Fax	01 204 0103
	Switchboard	01 204 4444
	U.K. Customer Service (dial within U.K. only)	0870 906 0010
	Corporate Customer Service (dial within U.K. only)	0870 907 4499
	U.K. Sales (dial within U.K. only)	0870 907 4000

Country (City) International Access Code Country Code City Code	Service Type	Area Codes, Local Numbers, and Toll-Free Numbers Web and E-mail Address
Italy (Milan)	Online Support	support.euro.dell.com
International Access Code: 00	Home and Small Business	
Country Code: 39	Technical Support	02 577 826 90
City Code: 02	Customer Service	02 696 821 14
	Fax	02 696 821 13
	Switchboard	02 696 821 12
	Corporate	
	Technical Support	02 577 826 90
	Customer Service	02 577 825 55
	Fax	02 575 035 30
	Switchboard	02 577 821
Jamaica	Online Support	la-techsupport@dell.com
	Technical Support, Customer Service, Sales (dial from within Jamaica only)	1-800-440-9205

Country (City) International Access Code Country Code City Code	Service Type	Area Codes, Local Numbers, and Toll-Free Numbers Web and E-mail Address
Japan (Kawasaki)	Online Support	support.jp.dell.com
International Access Code: 001	Technical Support – XPS computers only	toll-free: 0120-937-786
Country Code: 81	Technical Support outside of Japan – XPS computers only	81-44-520-1235
City Code: 44	Technical Support – Dimension and Inspiron	toll-free: 0120-198-226
	Technical Support outside of Japan – Dimension and Inspiron	81-44-520-1435
	Technical Support – Dell Precision, OptiPlex, and Latitude	toll-free: 0120-198-433
	Technical Support outside of Japan – Dell Precision, OptiPlex, and Latitude	81-44-556-3894
	Technical Support – Dell PowerApp, Dell PowerEdge, Dell PowerConnect, and Dell PowerVault	toll-free: 0120-198-498
	Technical Support outside of Japan – PowerApp, PowerEdge, PowerConnect, and PowerVault	81-44-556-4162
	Technical Support – Projectors, PDAs, Printers, Routers	toll-free: 0120-981-690
	Technical Support outside of Japan – Projectors, PDAs, Printers, Routers	81-44-556-3468
	Faxbox Service	044-556-3490
	24-Hour Automated Order Status Service	044-556-3801
	Customer Service	044-556-4240
	Business Sales Division – up to 400 employees	044-556-1465
	Preferred Accounts Division Sales – over 400 employees	044-556-3433
	Public Sales – government agencies, educational institutions, and medical institutions	044-556-5963
	Global Segment Japan	044-556-3469
	Individual User	044-556-1657
	Individual User Online Sales	044-556-2203
	Individual User Real Site Sales	044-556-4649

Country (City) International Access Code Country Code City Code	Service Type	Area Codes, Local Numbers, and Toll-Free Numbers Web and E-mail Address
Korea (Seoul) International Access Code: 001 Country Code: 82 City Code: 2	Online Support	support.ap.dell.com
	Technical Support for XPS computers only	toll-free: 080-999-0283
	Technical Support, Customer Service	toll-free: 080-200-3800
	Technical Support – Dimension, PDA, Electronics, and Accessories	toll-free: 080-200-3801
	Sales	toll-free: 080-200-3600
	Fax	2194-6202
	Switchboard	2194-6000
Latin America	Customer Technical Support (Austin, Texas, U.S.A.)	512 728-4093
	Customer Service (Austin, Texas, U.S.A.)	512 728-3619
	Fax (Technical Support and Customer Service) (Austin, Texas, U.S.A.)	512 728-3883
	Sales (Austin, Texas, U.S.A.)	512 728-4397
	Sales Fax (Austin, Texas, U.S.A.)	512 728-4600 or 512 728-3772
Luxembourg	Online Support	support.euro.dell.com
	Support	342 08 08 075
	Home/Small Business Sales	+32 (0)2 713 15 96
	Corporate Sales	26 25 77 81
	Customer Service	+32 (0)2 481 91 19
	Fax	26 25 77 82
Malaysia (Penang)	Online Support	support.ap.dell.com
	Technical Support – XPS computers only	toll-free: 1 800 885 784
	Technical Support – Dell Precision, OptiPlex, and Latitude	toll-free: 1 800 880 193
	Technical Support – Dimension, Inspiron, and Electronics and Accessories	toll-free: 1 800 881 306
	Technical Support – PowerApp, PowerEdge, PowerConnect, and PowerVault	toll-free: 1800 881 386
	Customer Service	toll-free: 1800 881 306 (option 6)
	Transaction Sales	toll-free: 1 800 888 202
Corporate Sales	toll-free: 1 800 888 213	

Country (City) International Access Code Country Code City Code	Service Type	Area Codes, Local Numbers, and Toll-Free Numbers Web and E-mail Address
Mexico International Access Code: 00 Country Code: 52	Online Support	www.dell.com/mx
		la-techsupport@dell.com
	Technical Support	001-866-563-4425
	Sales	50-81-8800 or 001-800-888-3355
	Customer Service	001-877-384-8979 or 001-877-269-3383
	Main	50-81-8800 or 001-800-888-3355 or 001-866-851-1754
Montserrat	Online Support	la-techsupport@dell.com
	Technical Support, Customer Service, Sales	toll-free: 1-866-278-6822
Netherlands Antilles	Online Support	la-techsupport@dell.com
	Technical Support, Customer Service, Sales	001-800-882-1519
Netherlands (Amsterdam) International Access Code: 00 Country Code: 31 City Code: 20	Online Support	support.euro.dell.com
	Technical Support for XPS computers only	020 674 45 94
	Technical Support	020 674 45 00
	Technical Support Fax	020 674 47 66
	Home/Small Business Customer Service	020 674 42 00
	Relational Customer Service	020 674 4325
	Home/Small Business Sales	020 674 55 00
	Relational Sales	020 674 50 00
	Home/Small Business Sales Fax	020 674 47 75
	Relational Sales Fax	020 674 47 50
	Switchboard	020 674 50 00
Switchboard Fax	020 674 47 50	
New Zealand International Access Code: 00 Country Code: 64	Online Support	support.ap.dell.com
		support.ap.dell.com/contactus
	Technical Support for XPS computers only	toll-free: 0800 335 540
	Technical Support, Customer Service, Sales	0800 441 567

Country (City) International Access Code Country Code City Code	Service Type	Area Codes, Local Numbers, and Toll-Free Numbers Web and E-mail Address
Nicaragua	Online Support	www.dell.com/ni la-techsupport@dell.com
	Technical Support, Customer Service, Sales	001-800-220-1377
Norway (Lysaker)	Online Support	support.euro.dell.com
International Access Code: 00	Technical Support for XPS computers only	815 35 043
Country Code: 47	Technical Support	671 16882
	Relational Customer Service	671 17575
	Home/Small Business Customer Service	23162298
	Switchboard	671 16800
	Fax Switchboard	671 16865
Panama	Online Support	www.dell.com/pa la-techsupport@dell.com
	Technical Support, Customer Service, Sales	011-800-507-1264
Peru	Online Support	www.dell.com/pe la-techsupport@dell.com
	Technical Support, Customer Service, Sales	0800-50-669
Poland (Warsaw)	Online Support	support.euro.dell.com
International Access Code: 011		pl_support_tech@dell.com
Country Code: 48	Customer Service Phone	57 95 700
City Code: 22	Customer Service	57 95 999
	Sales	57 95 999
	Customer Service Fax	57 95 806
	Reception Desk Fax	57 95 998
	Switchboard	57 95 999
Portugal	Online Support	support.euro.dell.com
International Access Code: 00	Technical Support	707200149
Country Code: 351	Customer Service	800 300 413
	Sales	800 300 410 or 800 300 411 or 800 300 412 or 21 422 07 10
	Fax	21 424 01 12

Country (City) International Access Code Country Code City Code	Service Type	Area Codes, Local Numbers, and Toll-Free Numbers Web and E-mail Address
Puerto Rico	Online Support	www.dell.com/pr la-techsupport@dell.com
	Technical Support	toll-free: 1-866-390-4695 or 1-866-851-1760
	Customer Service and Sales	1-877-537-3355
St. Kitts and Nevis	Online Support	www.dell.com/kn la-techsupport@dell.com
	Technical Support, Customer Service, Sales	toll-free: 1-866-540-3355
St. Lucia	Online Support	www.dell.com/lc la-techsupport@dell.com
	Technical Support, Customer Service, Sales	toll-free: 1-866-464-4352
St. Vincent and the Grenadines	Online Support	www.dell.com/vc la-techsupport@dell.com
	Technical Support, Customer Service, Sales	toll-free: 1-866-464-4353
Singapore (Singapore) International Access Code: 005 Country Code: 65	NOTE: The phone numbers in this section should be called from within Singapore or Malaysia only.	
	Online Support	support.ap.dell.com
	Technical Support – XPS computers only	toll-free: 1 800 394 7464
	Technical Support – Dimension, Inspiron, and Electronics and Accessories	toll-free: 1 800 394 7430
	Technical Support – OptiPlex, Latitude, and Dell Precision	toll-free: 1 800 394 7488
	Technical Support – PowerApp, PowerEdge, PowerConnect, and PowerVault	toll-free: 1 800 394 7478
	Customer Service	toll-free: 1 800 394 7430 (option 6)
	Transaction Sales	toll-free: 1 800 394 7412
	Corporate Sales	toll-free: 1 800 394 7419

Country (City) International Access Code Country Code City Code	Service Type	Area Codes, Local Numbers, and Toll-Free Numbers Web and E-mail Address
Slovakia (Prague) International Access Code: 00 Country Code: 421	Online Support	support.euro.dell.com czech_dell@dell.com
	Technical Support	02 5441 5727
	Customer Service	420 22537 2707
	Fax	02 5441 8328
	Tech Fax	02 5441 8328
	Switchboard (Sales)	02 5441 7585
South Africa (Johannesburg) International Access Code: 09/091 Country Code: 27 City Code: 11	Online Support	support.euro.dell.com dell_za_support@dell.com
	Gold Queue	011 709 7713
	Technical Support	011 709 7710
	Customer Service	011 709 7707
	Sales	011 709 7700
	Fax	011 706 0495
	Switchboard	011 709 7700
Southeast Asian and Pacific Countries	Technical Support, Customer Service, and Sales (Penang, Malaysia)	604 633 4810
Spain (Madrid) International Access Code: 00 Country Code: 34 City Code: 91	Online Support	support.euro.dell.com
	Home and Small Business	
	Technical Support	902 100 130
	Customer Service	902 118 540
	Sales	902 118 541
	Switchboard	902 118 541
	Fax	902 118 539
	Corporate	
	Technical Support	902 100 130
	Customer Service	902 115 236
	Switchboard	91 722 92 00
Fax	91 722 95 83	

Country (City) International Access Code Country Code City Code	Service Type	Area Codes, Local Numbers, and Toll-Free Numbers Web and E-mail Address
Sweden (Upplands Vasby) International Access Code: 00 Country Code: 46 City Code: 8	Online Support	support.euro.dell.com
	Technical Support for XPS computers only	77 134 03 40
	Technical Support	08 590 05 199
	Relational Customer Service	08 590 05 642
	Home/Small Business Customer Service	08 587 70 527
	Employee Purchase Program (EPP) Support	020 140 14 44
	Technical Support Fax	08 590 05 594
	Sales	08 587 705 81
Switzerland (Geneva) International Access Code: 00 Country Code: 41 City Code: 22	Online Support	support.euro.dell.com
		Tech_support_central_Europe@dell.com
	Technical Support for XPS computers only	0848 338 857
	Technical Support – Home and Small Business	0844 811 411
	Technical Support – Corporate	0844 822 844
	Customer Service – Home and Small Business	0848 802 202
	Customer Service – Corporate	0848 821 721
	Main	0848 335 599
	Fax	022 799 01 90
	Sales	022 799 01 01
Taiwan International Access Code: 002 Country Code: 886	Online Support	support.ap.dell.com
		support.dell.com.cn/email
	Technical Support – XPS computers only	toll-free: 0080 186 3085
	Technical Support – OptiPlex, Latitude, Inspiron, Dimension, and Electronics and Accessories	toll-free: 0080 186 1011
	Technical Support – Servers and Storage	toll-free: 0080 160 1256
	Customer Service	toll-free: 0080 160 1250 (option 5)
	Transaction Sales	toll-free: 0080 165 1228
	Corporate Sales	toll-free: 0080 165 1227

Country (City) International Access Code Country Code City Code	Service Type	Area Codes, Local Numbers, and Toll-Free Numbers Web and E-mail Address
Thailand International Access Code: 001 Country Code: 66	Online Support	support.ap.dell.com
	Technical Support (OptiPlex, Latitude, and Dell Precision)	toll-free: 1800 0060 07
	Technical Support (PowerApp, PowerEdge, PowerConnect, and PowerVault)	toll-free: 1800 0600 09
	Customer Service	toll-free: 1800 006 007 (option 7)
	Corporate Sales	toll-free: 1800 006 009
	Transaction Sales	toll-free: 1800 006 006
Trinidad/Tobago	Online Support	www.dell.com/tt la-techsupport@dell.com
	Technical Support, Customer Service, Sales	toll-free: 1-888-799-5908
Turks and Caicos Islands	Online Support	www.dell.com/tc la-techsupport@dell.com
	Technical Support, Customer Service, Sales	toll-free: 1-877-441-4735

Country (City) International Access Code Country Code City Code	Service Type	Area Codes, Local Numbers, and Toll-Free Numbers Web and E-mail Address
U.K. (Bracknell) International Access Code: 00 Country Code: 44 City Code: 1344	Online Support	support.euro.dell.com dell_direct_support@dell.com
	Customer Service Online	support.euro.dell.com/uk/en/ECare/form/home.asp
	Sales	
	Home and Small Business Sales	0870 907 4000
	Corporate/Public Sector Sales	01344 860 456
	Customer Service	
	Home and Small Business	0870 906 0010
	Corporate	01344 373 185
	Preferred Accounts (500–5000 employees)	0870 906 0010
	Global Accounts	01344 373 186
	Central Government	01344 373 193
	Local Government & Education	01344 373 199
	Health	01344 373 194
	Technical Support	
	XPS Computers Only	0870 366 4180
	Corporate/Preferred Accounts/PCA (1000+ employees)	0870 908 0500
	Other Dell Products	0870 353 0800
General		
Home and Small Business Fax	0870 907 4006	
Uruguay	Online Support	www.dell.com/uy la-techsupport@dell.com
	Technical Support, Customer Service, Sales	toll-free: 000-413-598-2521

Country (City) International Access Code Country Code City Code	Service Type	Area Codes, Local Numbers, and Toll-Free Numbers Web and E-mail Address
U.S.A. (Austin, Texas) International Access Code: 011 Country Code: 1	Dell Services for the Deaf, Hard-of-Hearing, or Speech-Impaired	toll-free: 1-877-DELLTY (1-877-335-5889)
	Fax	toll-free: 1-800-727-8320
	Technical Support	support.dell.com
	XPS	toll-free: 1-800-232-8544
	Home and Home Office	toll-free: 1-800-624-9896
	Portable and Desktop AutoTech	toll-free: 1-800-247-9362
	Small Business	toll-free: 1-800-456-3355
	Medium and Large Business	toll-free: 1-877-671-3355
	State and Local Government	toll-free: 1-800-981-3355
	Federal Government	toll-free: 1-800-727-1100
	Healthcare	toll-free: 1-800-274-1550
	K-12 Education	toll-free: 1-888-977-3355
	Higher Education	toll-free: 1-800-274-7799
	Printers, Projectors, PDAs, and MP3 Players	toll-free: 1-877-459-7298
	Customer Service	toll-free: 1-800-624-9897
	Automated Order Status	toll-free: 1-800-433-9014
	Small Business	toll-free: 1-800-456-3355
	Medium and Large Business	toll-free: 1-877-671-3355
	State and Local Government	toll-free: 1-800-981-3355
	Federal Government	toll-free: 1-800-727-1100
	Healthcare	toll-free: 1-800-274-1550
	K-12 Education	toll-free: 1-888-977-3355
	Higher Education	toll-free: 1-800-274-7799
	Employee Purchase Program (EPP)	toll-free: 1-800-695-8133
	Financial Services	www.dellfinancialservices.com
	Leases and Loans	toll-free: 1-877-577-3355
	Dell Preferred Accounts (DPA)	toll-free: 1-800-283-2210
	Sales	1-800-289-3355 or 1-800-879-3355
	Dell Outlet Store	toll-free: 1-888-798-7561
	Software and Peripherals Sales	toll-free: 1-800-671-3355

Country (City) International Access Code Country Code City Code	Service Type	Area Codes, Local Numbers, and Toll-Free Numbers Web and E-mail Address
U.S. Virgin Islands	Online Support	www.dell.com/vi la-techsupport@dell.com
	Technical Support, Customer Service, Sales	toll-free: 1-877-702-4360
Venezuela	Online Support	www.dell.com/ve la-techsupport@dell.com
	Technical Support, Customer Service, Sales	0800-100-4752

Glossary

Terms in this Glossary are provided for informational purposes only and may or may not describe features included with your particular computer.

A

AC — alternating current — The form of electricity that powers your computer when you plug the AC adapter power cable in to an electrical outlet.

ACPI — advanced configuration and power interface — A power management specification that enables Microsoft® Windows® operating systems to put a computer in standby or hibernate mode to conserve the amount of electrical power allocated to each device attached to the computer.

AGP — accelerated graphics port — A dedicated graphics port that allows system memory to be used for video-related tasks. AGP delivers a smooth, true-color video image because of the faster interface between the video circuitry and the computer memory.

AHCI — Advanced Host Controller Interface — An interface for a SATA hard drive Host Controller which allows the storage driver to enable technologies such as Native Command Queuing (NCQ) and hot plug.

ALS — ambient light sensor — A feature that helps to control display brightness.

antivirus software — A program designed to identify, quarantine, and/or delete viruses from your computer.

ASF — alert standards format — A standard to define a mechanism for reporting hardware and software alerts to a management console. ASF is designed to be platform- and operating system-independent.

B

battery life span — The length of time (years) during which a portable computer battery is able to be depleted and recharged.

battery operating time — The length of time (minutes or hours) that a portable computer battery powers the computer.

BIOS — basic input/output system — A program (or utility) that serves as an interface between the computer hardware and the operating system. Unless you understand what effect these settings have on the computer, do not change them. Also referred to as *system setup*.

bit — The smallest unit of data interpreted by your computer.

Blu-ray Disc™ (BD) — An optical storage technology offering storage capacity of up to 50 GB, full 1080p video resolution (HDTV required), and as many as 7.1 channels of native, uncompressed surround sound.

Bluetooth® wireless technology — A wireless technology standard for short-range (9 m [29 feet]) networking devices that allows for enabled devices to automatically recognize each other.

boot sequence — Specifies the order of the devices from which the computer attempts to boot.

bootable media — A CD, DVD, or floppy disk that you can use to start your computer. In case your hard drive is damaged or your computer has a virus, ensure that you always have a bootable CD, DVD, or floppy disk available. Your *Drivers and Utilities* media is an example of bootable media.

bps — bits per second — The standard unit for measuring data transmission speed.

BTU — British thermal unit — A measurement of heat output.

bus — A communication pathway between the components in your computer.

bus speed — The speed, given in MHz, that indicates how fast a bus can transfer information.

byte — The basic data unit used by your computer. A byte is usually equal to 8 bits.

C

C — Celsius — A temperature measurement scale where 0° is the freezing point and 100° is the boiling point of water.

cache — A special high-speed storage mechanism which can be either a reserved section of main memory or an independent high-speed storage device. The cache enhances the efficiency of many processor operations.

L1 cache — Primary cache stored inside the processor.

L2 cache — Secondary cache which can either be external to the processor or incorporated into the processor architecture.

carnet — An international customs document that facilitates temporary imports into foreign countries. Also known as a *merchandise passport*.

CD-R — CD recordable — A recordable version of a CD. Data can be recorded only once onto a CD-R. Once recorded, the data cannot be erased or written over.

CD-RW — CD rewritable — A rewritable version of a CD. Data can be written to a CD-RW disc, and then erased and written over (rewritten).

CD-RW drive — A drive that can read CDs and write to CD-RW (rewritable CDs) and CD-R (recordable CDs) discs. You can write to CD-RW discs multiple times, but you can write to CD-R discs only once.

CD-RW/DVD drive — A drive, sometimes referred to as a combo drive, that can read CDs and DVDs and write to CD-RW (rewritable CDs) and CD-R (recordable CDs) discs. You can write to CD-RW discs multiple times, but you can write to CD-R discs only once.

clock speed — The speed, given in MHz, that indicates how fast computer components that are connected to the system bus operate.

CMOS — A type of electronic circuit. Computers use a small amount of battery-powered CMOS memory to hold date, time, and system setup options.

COA — Certificate of Authenticity — The Windows alpha-numeric code located on a sticker on your computer. Also referred to as the *Product Key* or *Product ID*.

Control Panel — A Windows utility that allows you to modify operating system and hardware settings, such as display settings.

controller — A chip that controls the transfer of data between the processor and memory or between the processor and devices.

CRIMM — continuity rambus in-line memory module — A special module that has no memory chips and is used to fill unused RIMM slots.

cursor — The marker on a display or screen that shows where the next keyboard, touch pad, or mouse action will occur. It often is a blinking solid line, an underline character, or a small arrow.

D

DDR SDRAM — double-data-rate SDRAM — A type of SDRAM that doubles the data burst cycle, improving system performance.

DDR2 SDRAM — double-data-rate 2 SDRAM — A type of DDR SDRAM that uses a 4-bit prefetch and other architectural changes to boost memory speed to over 400 MHz.

device — Hardware such as a disk drive, printer, or keyboard that is installed in or connected to your computer.

device driver — See *driver*.

DIMM — dual in-line memory module — A circuit board with memory chips that connects to a memory module on the system board.

DIN connector — A round, six-pin connector that conforms to DIN (Deutsche Industrie-Norm) standards; it is typically used to connect PS/2 keyboard or mouse cable connectors.

disk striping — A technique for spreading data over multiple disk drives. Disk striping can speed up operations that retrieve data from disk storage. Computers that use disk striping generally allow the user to select the data unit size or stripe width.

DMA — direct memory access — A channel that allows certain types of data transfer between RAM and a device to bypass the processor.

docking device — See *APR*.

DMTF — Distributed Management Task Force — A consortium of hardware and software companies who develop management standards for distributed desktop, network, enterprise, and Internet environments.

domain — A group of computers, programs, and devices on a network that are administered as a unit with common rules and procedures for use by a specific group of users. A user logs on to the domain to gain access to the resources.

DRAM — dynamic random-access memory — Memory that stores information in integrated circuits containing capacitors.

driver — Software that allows the operating system to control a device such as a printer. Many devices do not work properly if the correct driver is not installed in the computer.

DSL — Digital Subscriber Line — A technology that provides a constant, high-speed Internet connection through an analog telephone line.

dual-core — A technology in which two physical computational units exist inside a single processor package, thereby increasing computing efficiency and multi-tasking ability.

dual display mode — A display setting that allows you to use a second monitor as an extension of your display. Also referred to as *extended display mode*.

DVD-R — DVD recordable — A recordable version of a DVD. Data can be recorded only once onto a DVD-R. Once recorded, the data cannot be erased or written over.

DVD+RW — DVD rewritable — A rewritable version of a DVD. Data can be written to a DVD+RW disc, and then erased and written over (rewritten). (DVD+RW technology is different from DVD-RW technology.)

DVD+RW drive — drive that can read DVDs and most CD media and write to DVD+RW (rewritable DVDs) discs.

DVI — digital video interface — A standard for digital transmission between a computer and a digital video display.

E

ECC — error checking and correction — A type of memory that includes special circuitry for testing the accuracy of data as it passes in and out of memory.

ECP — extended capabilities port — A parallel connector design that provides improved bidirectional data transmission. Similar to EPP, ECP uses direct memory access to transfer data and often improves performance.

EIDE — enhanced integrated device electronics — An improved version of the IDE interface for hard drives and CD drives.

EMI — electromagnetic interference — Electrical interference caused by electromagnetic radiation.

ENERGY STAR[®] — Environmental Protection Agency requirements that decrease the overall consumption of electricity.

EPP — enhanced parallel port — A parallel connector design that provides bidirectional data transmission.

ESD — electrostatic discharge — A rapid discharge of static electricity. ESD can damage integrated circuits found in computer and communications equipment.

expansion card — A circuit board that installs in an expansion slot on the system board in some computers, expanding the capabilities of the computer. Examples include video, modem, and sound cards.

expansion slot — A connector on the system board (in some computers) where you insert an expansion card, connecting it to the system bus.

ExpressCard — A removable I/O card adhering to the PCMCIA standard. Modems and network adapters are common types of ExpressCards. ExpressCards support both the PCI Express and USB 2.0 standard.

Express Service Code — A numeric code located on a sticker on your Dell™ computer. Use the Express Service Code when contacting Dell for assistance. Express Service Code service may not be available in some countries.

extended display mode — A display setting that allows you to use a second monitor as an extension of your display. Also referred to as *dual display mode*.

extended PC Card — A PC Card that extends beyond the edge of the PC Card slot when installed.

F

Fahrenheit — A temperature measurement scale where 32° is the freezing point and 212° is the boiling point of water.

FBD — fully-buffered DIMM — A DIMM with DDR2 DRAM chips and an Advanced Memory Buffer (AMB) that speeds communication between the DDR2 SDRAM chips and the system.

FCC — Federal Communications Commission — A U.S. agency responsible for enforcing communications-related regulations that state how much radiation computers and other electronic equipment can emit.

fingerprint reader — A strip sensor that uses your unique fingerprint to authenticate your user identity to help secure your computer.

folder — A term used to describe space on a disk or drive where files are organized and grouped. Files in a folder can be viewed and ordered in various ways, such as alphabetically, by date, and by size.

format — The process that prepares a drive or disk for file storage. When a drive or disk is formatted, the existing information on it is lost.

FSB — front side bus — The data path and physical interface between the processor and RAM.

FTP — file transfer protocol — A standard Internet protocol used to exchange files between computers connected to the Internet.

G

G — gravity — A measurement of weight and force.

GB — gigabyte — A measurement of data storage that equals 1024 MB (1,073,741,824 bytes). When used to refer to hard drive storage, the term is often rounded to 1,000,000,000 bytes.

GHz — gigahertz — A measurement of frequency that equals one thousand million Hz, or one thousand MHz. The speeds for computer processors, buses, and interfaces are often measured in GHz.

graphics mode — A video mode that can be defined as x horizontal pixels by y vertical pixels by z colors. Graphics modes can display an unlimited variety of shapes and fonts.

GUI — graphical user interface — Software that interacts with the user by means of menus, windows, and icons. Most programs that operate on the Windows operating systems are GUIs.

H

hard drive — A drive that reads and writes data on a hard disk. The terms hard drive and hard disk are often used interchangeably.

heat sink — A metal plate on some processors that helps dissipate heat.

hibernate mode — A power management mode that saves everything in memory to a reserved space on the hard drive and then turns off the computer. When you restart the computer, the memory information that was saved to the hard drive is automatically restored.

HTTP — hypertext transfer protocol — A protocol for exchanging files between computers connected to the Internet.

Hyper-Threading — Hyper-Threading is an Intel technology that can enhance overall computer performance by allowing one physical processor to function as two logical processors, capable of performing certain tasks simultaneously.

Hz — hertz — A unit of frequency measurement that equals 1 cycle per second. Computers and electronic devices are often measured in kilohertz (kHz), megahertz (MHz), gigahertz (GHz), or terahertz (THz).

I

IC — integrated circuit — A semiconductor wafer, or chip, on which thousands or millions of tiny electronic components are fabricated for use in computer, audio, and video equipment.

IDE — integrated device electronics — An interface for mass storage devices in which the controller is integrated into the hard drive or CD drive.

IEEE 1394 — Institute of Electrical and Electronics Engineers, Inc. — A high-performance serial bus used to connect IEEE 1394-compatible devices, such as digital cameras and DVD players, to the computer.

infrared sensor — A port that allows you to transfer data between the computer and infrared-compatible devices without using a cable connection.

integrated — Usually refers to components that are physically located on the computer's system board. Also referred to as *built-in*.

I/O — input/output — An operation or device that enters and extracts data from your computer. Keyboards and printers are I/O devices.

I/O address — An address in RAM that is associated with a specific device (such as a serial connector, parallel connector, or expansion slot) and allows the processor to communicate with that device.

IrDA — Infrared Data Association — The organization that creates international standards for infrared communications.

IRQ — interrupt request — An electronic pathway assigned to a specific device so that the device can communicate with the processor. Each device connection must be assigned an IRQ. Although two devices can share the same IRQ assignment, you cannot operate both devices simultaneously.

ISP — Internet service provider — A company that allows you to access its host server to connect directly to the

Internet, send and receive e-mail, and access websites. The ISP typically provides you with a software package, user name, and access phone numbers for a fee.

K

Kb — kilobit — A unit of data that equals 1024 bits. A measurement of the capacity of memory integrated circuits.

KB — kilobyte — A unit of data that equals 1024 bytes but is often referred to as 1000 bytes.

key combination — A command requiring you to press multiple keys at the same time.

kHz — kilohertz — A measurement of frequency that equals 1000 Hz.

L

LAN — local area network — A computer network covering a small area. A LAN usually is confined to a building or a few nearby buildings. A LAN can be connected to another LAN over any distance through telephone lines and radio waves to form a wide area network (WAN).

LCD — liquid crystal display — The technology used by portable computer and flat-panel displays.

LED — light-emitting diode — An electronic component that emits light to indicate the status of the computer.

local bus — A data bus that provides a fast throughput for devices to the processor.

LPT — line print terminal — The designation for a parallel connection to a printer or other parallel device.

M

Mb — megabit — A measurement of memory chip capacity that equals 1024 Kb.

Mbps — megabits per second — One million bits per second. This measurement is typically used for transmission speeds for networks and modems.

MB — megabyte — A measurement of data storage that equals 1,048,576 bytes. 1 MB equals 1024 KB. When used to refer to hard drive storage, the term is often rounded to 1,000,000 bytes.

MB/sec — megabytes per second — One million bytes per second. This measurement is typically used for data transfer ratings.

media bay — A bay that supports devices such as optical drives, a second battery, or a Dell TravelLite™ module.

memory — A temporary data storage area inside your computer. Because the data in memory is not permanent, it is recommended that you frequently save your files while you are working on them, and always save your files before you shut down the computer. Your computer can contain several different forms of memory, such as RAM, ROM, and video memory. Frequently, the word memory is used as a synonym for RAM.

memory address — A specific location where data is temporarily stored in RAM.

memory mapping — The process by which the computer assigns memory addresses to physical locations at start-up. Devices and software can then identify information that the processor can access.

memory module — A small circuit board containing memory chips, which connects to the system board.

MHz — megahertz — A measure of frequency that equals 1 million cycles per second. The speeds for computer processors, buses, and interfaces are often measured in MHz.

Mini PCI — A standard for integrated peripheral devices with an emphasis on communications such as modems and NICs. A Mini PCI card is a small external card that is functionally equivalent to a standard PCI expansion card.

Mini-Card — A small card designed for integrated peripherals, such as communication NICs. The Mini-Card is functionally equivalent to a standard PCI expansion card.

modem — A device that allows your computer to communicate with other computers over analog telephone lines. Three types of modems include: external, PC Card, and internal. You typically use your modem to connect to the Internet and exchange e-mail.

module bay — See *media bay*.

MP — megapixel — A measure of image resolution used for digital cameras.

ms — millisecond — A measure of time that equals one thousandth of a second. Access times of storage devices are often measured in ms.

N

network adapter — A chip that provides network capabilities. A computer may include a network adapter on its system board, or it may contain a PC Card with an adapter on it. A network adapter is also referred to as a NIC (network interface controller).

NIC — See *network adapter*.

notification area — The section of the Windows taskbar that contains icons for providing quick access to programs and computer functions, such as the clock, volume control, and print status. Also referred to as *system tray*.

ns — nanosecond — A measure of time that equals one billionth of a second.

NVRAM — nonvolatile random access memory — A type of memory that stores data when the computer is turned off or loses its external power source. NVRAM is used for maintaining computer configuration information such as date, time, and other system setup options that you can set.

O

optical drive — A drive that uses optical technology to read or write data from CDs, DVDs, or DVD+RWs. Example of optical drives include CD drives, DVD drives, CD-RW drives, and CD-RW/DVD combo drives.

P

parallel connector — An I/O port often used to connect a parallel printer to your computer. Also referred to as an *LPT port*.

partition — A physical storage area on a hard drive that is assigned to one or more logical storage areas known as

logical drives. Each partition can contain multiple logical drives.

PC Card — A removable I/O card adhering to the PCMCIA standard. Modems and network adapters are common types of PC Cards.

PCI — peripheral component interconnect — PCI is a local bus that supports 32- and 64-bit data paths, providing a high-speed data path between the processor and devices such as video, drives, and networks.

PCI Express — A modification to the PCI interface that boosts the data transfer rate between the processor and the devices attached to it. PCI Express can transfer data at speeds from 250 MB/sec to 4 GB/sec. If the PCI Express chip set and the device are capable of different speeds, they will operate at the slower speed.

PCMCIA — Personal Computer Memory Card International Association — The organization that establishes standards for PC Cards.

PIO — programmed input/output — A method of transferring data between two devices through the processor as part of the data path.

pixel — A single point on a display screen. Pixels are arranged in rows and columns to create an image. A video resolution, such as 800 x 600, is expressed as the number of pixels across by the number of pixels up and down.

Plug-and-Play — The ability of the computer to automatically configure devices. Plug and Play provides automatic installation, configuration, and compatibility with existing hardware if the BIOS, operating system, and all devices are Plug and Play compliant.

POST — power-on self-test — Diagnostics programs, loaded automatically by the BIOS, that perform basic tests on the major computer components, such as memory, hard drives, and video. If no problems are detected during POST, the computer continues the start-up.

processor — A computer chip that interprets and executes program instructions. Sometimes the processor is referred to as the CPU (central processing unit).

PS/2 — personal system/2 — A type of connector for attaching a PS/2-compatible keyboard, mouse, or keypad.

PXE — pre-boot execution environment — A WfM (Wired for Management) standard that allows networked computers that do not have an operating system to be configured and started remotely.

R

RAID — redundant array of independent disks — A method of providing data redundancy. Some common implementations of RAID include RAID 0, RAID 1, RAID 5, RAID 10, and RAID 50.

RAM — random-access memory — The primary temporary storage area for program instructions and data. Any information stored in RAM is lost when you shut down your computer.

readme file — A text file included with a software package or hardware product. Typically, readme files provide installation information and describe new product enhancements or corrections that have not yet been documented.

read-only — Data and/or files you can view but cannot edit or delete. A file can have read-only status if:

- It resides on a physically write-protected floppy disk, CD, or DVD.
- It is located on a network in a directory and the system administrator has assigned rights only to specific individuals.

refresh rate — The frequency, measured in Hz, at which your screen's horizontal lines are recharged (sometimes also referred to as its *vertical frequency*). The higher the refresh rate, the less video flicker can be seen by the human eye.

resolution — The sharpness and clarity of an image produced by a printer or displayed on a monitor. The higher the resolution, the sharper the image.

RFI — radio frequency interference — Interference that is generated at typical radio frequencies, in the range of 10 kHz to 100,000 MHz. Radio frequencies are at the lower end of the electromagnetic frequency spectrum and are more likely to have interference than the higher frequency radiations, such as infrared and light.

ROM — read-only memory — Memory that stores data and programs that cannot be deleted or written to by the computer. ROM, unlike RAM, retains its contents after you shut down your computer. Some programs essential to the operation of your computer reside in ROM.

RPM — revolutions per minute — The number of rotations that occur per minute. Hard drive speed is often measured in rpm.

RTC — real time clock — Battery-powered clock on the system board that keeps the date and time after you shut down the computer.

RTCIRST — real-time clock reset — A jumper on the system board of some computers that can often be used for troubleshooting problems.

S

SAS — serial attached SCSI — A faster, serial version of the SCSI interface (as opposed to the original SCSI parallel architecture).

SATA — serial ATA — A faster, serial version of the ATA (IDE) interface.

ScanDisk — A Microsoft utility that checks files, folders, and the hard disk's surface for errors. ScanDisk often runs when you restart the computer after it has stopped responding.

SCSI — small computer system interface — A high-speed interface used to connect devices to a computer, such as hard drives, CD drives, printers, and scanners. The SCSI can connect many devices using a single controller. Each device is accessed by an individual identification number on the SCSI controller bus.

SDRAM — synchronous dynamic random-access memory — A type of DRAM that is synchronized with the optimal clock speed of the processor.

serial connector — An I/O port often used to connect devices such as a handheld digital device or digital camera to your computer.

Service Tag — A bar code label on your computer that identifies your computer when you access Dell Support at support.dell.com or when you call Dell for customer service or technical support.

setup program — A program that is used to install and configure hardware and software. The **setup.exe** or **install.exe** program comes with most Windows software packages. *Setup program* differs from *system setup*.

shortcut — An icon that provides quick access to frequently used programs, files, folders, and drives. When you place a shortcut on your Windows desktop and double-click the icon, you can open its corresponding folder or file without having to find it first. Shortcut icons do not change the location of files. If you delete a shortcut, the original file is not affected. Also, you can rename a shortcut icon.

SIM — Subscriber Identity Module — A SIM card contains a microchip that encrypts voice and data transmissions. SIM cards can be used in phones or portable computers.

smart card — A card that is embedded with a processor and a memory chip. Smart cards can be used to authenticate a user on computers equipped for smart cards.

S/PDIF — Sony/Philips Digital Interface — An audio transfer file format that allows the transfer of audio from one file to another without converting it to and from an analog format, which could degrade the quality of the file.

standby mode — A power management mode that shuts down all unnecessary computer operations to save energy.

Strike Zone™ — Reinforced area of the platform base that protects the hard drive by acting as a dampening device when a computer experiences resonating shock or is dropped (whether the computer is on or off).

surge protectors — Prevent voltage spikes, such as those that may occur during an electrical storm, from entering the computer through the electrical outlet. Surge protectors do not protect against lightning strikes or against brownouts, which occur when the voltage drops more than 20 percent below the normal AC-line voltage level.

Network connections cannot be protected by surge protectors. Always disconnect the network cable from the network connector during electrical storms.

SVGA — super-video graphics array — A video standard for video cards and controllers. Typical SVGA resolutions are 800 x 600 and 1024 x 768.

The number of colors and resolution that a program displays depends on the capabilities of the monitor, the video controller and its drivers, and the amount of video memory installed in the computer.

S-video TV-out — A connector used to attach a TV or digital audio device to the computer.

SXGA — super-extended graphics array — A video standard for video cards and controllers that supports resolutions up to 1280 x 1024.

SXGA+ — super-extended graphics array plus — A video standard for video cards and controllers that supports resolutions up to 1400 x 1050.

system board — The main circuit board in your computer. Also known as the *motherboard*.

system setup — A utility that serves as an interface between the computer hardware and the operating system. System setup allows you to configure user-selectable options in the BIOS, such as date and time or system password. Unless you understand what effect the settings have on the computer, do not change the settings for this program.

T

TAPI — telephony application programming interface — Enables Windows programs to operate with a wide variety of telephony devices, including voice, data, fax, and video.

text editor — A program used to create and edit files that contain only text; for example, Windows Notepad uses a text editor. Text editors do not usually provide word wrap or formatting functionality (the option to underline, change fonts, and so on).

TPM — trusted platform module — A hardware-based security feature that when combined with security software enhances network and computer security by enabling features such as file and e-mail protection.

travel module — A plastic device designed to fit inside the module bay of a portable computer to reduce the weight of the computer.

U

UAC — user account control— Microsoft Windows® Vista™ security feature that, when enabled, provides an added layer of security between user accounts and access to operating system settings.

UMA — unified memory allocation — System memory dynamically allocated to video.

UPS — uninterruptible power supply — A backup power source used when the electrical power fails or drops to an unacceptable voltage level. A UPS keeps a computer running for a limited amount of time when there is no electrical power. UPS systems typically provide surge suppression and may also provide voltage regulation. Small UPS systems provide battery power for a few minutes to enable you to shut down your computer.

USB — universal serial bus — A hardware interface for a low-speed device such as a USB-compatible keyboard, mouse, joystick, scanner, set of speakers, printer, broadband devices (DSL and cable modems), imaging devices, or storage devices. Devices are plugged directly into a 4-pin socket on your computer or into a multi-port hub that plugs into your computer. USB devices can be connected and disconnected while the computer is turned on, and they can also be daisy-chained together.

UTP — unshielded twisted pair — Describes a type of cable used in most telephone networks and some computer networks. Pairs of unshielded wires are twisted to protect against electromagnetic interference, rather than relying on a metal sheath around each pair of wires to protect against interference.

UXGA — ultra extended graphics array — A video standard for video cards and controllers that supports resolutions up to 1600 x 1200.

V

video controller — The circuitry on a video card or on the system board (in computers with an integrated video controller) that provides the video capabilities—in combination with the monitor—for your computer.

video memory — Memory that consists of memory chips dedicated to video functions. Video memory is usually

faster than system memory. The amount of video memory installed primarily influences the number of colors that a program can display.

video mode — A mode that describes how text and graphics are displayed on a monitor. Graphics-based software, such as Windows operating systems, displays in video modes that can be defined as x horizontal pixels by y vertical pixels by z colors. Character-based software, such as text editors, displays in video modes that can be defined as x columns by y rows of characters.

video resolution — See *resolution*.

virus — A program that is designed to inconvenience you or to destroy data stored on your computer. A virus program moves from one computer to another through an infected disk, software downloaded from the Internet, or e-mail attachments. When an infected program starts, its embedded virus also starts.

A common type of virus is a boot virus, which is stored in the boot sectors of a floppy disk. If the floppy disk is left in the drive when the computer is shut down and then turned on, the computer is infected when it reads the boot sectors of the floppy disk expecting to find the operating system. If the computer is infected, the boot virus may replicate itself onto all the floppy disks that are read or written in that computer until the virus is eradicated.

V — volt — The measurement of electric potential or electromotive force. One V appears across a resistance of 1 ohm when a current of 1 ampere flows through that resistance.

W

W — watt — The measurement of electrical power. One W is 1 ampere of current flowing at 1 volt.

WHr — watt-hour — A unit of measure commonly used to indicate the approximate capacity of a battery. For example, a 66-WHr battery can supply 66 W of power for 1 hour or 33 W for 2 hours.

wallpaper — The background pattern or picture on the Windows desktop. Change your wallpaper through the Windows Control Panel. You can also scan in your favorite picture and make it wallpaper.

WLAN — wireless local area network. A series of interconnected computers that communicate with each other over the air waves using access points or wireless routers to provide Internet access.

write-protected — Files or media that cannot be changed. Use write-protection when you want to protect data from being changed or destroyed. To write-protect a 3.5-inch floppy disk, slide its write-protect tab to the open position.

WWAN — wireless wide area network. A wireless high-speed data network using cellular technology and covering a much larger geographic area than WLAN.

WXGA — wide-aspect extended graphics array — A video standard for video cards and controllers that supports resolutions up to 1280 x 800."

X

XGA — extended graphics array — A video standard for video cards and controllers that supports resolutions up to 1024 x 768.

Z

ZIF — zero insertion force — A type of socket or connector that allows a computer chip to be installed or removed with no stress applied to either the chip or its socket.

Zip — A popular data compression format. Files that have been compressed with the Zip format are called Zip files and usually have a filename extension of **.zip**. A special kind of zipped file is a self-extracting file, which has a filename extension of **.exe**. You can unzip a self-extracting file by double-clicking it.

Zip drive — A high-capacity floppy drive developed by Iomega Corporation that uses 3.5-inch removable disks called Zip disks. Zip disks are slightly larger than regular floppy disks, about twice as thick, and hold up to 100 MB of data.

Index

A

audio. See *sound*

B

battery

- problems, 53
- replacing, 158

BDs

- about, 38

beep codes, 69

BIOS, 168

boot sequence

- changing, 175-176
- option settings, 175

booting

- to a USB device, 175

C

cards

- slots, 16

CD-RW drive

- problems, 54

CDs

- about, 38

Check Disk, 54

cleaning your computer, 178

CMOS settings

- clearing, 177

computer

- beep codes, 69
- components inside, 88
- crashes, 58-59
- inside view, 88
- stops responding, 58

conflicts

- software and hardware incompatibilities, 83

connectors

- center subwoofer/LFE, 18
- headphone, 15, 18
- IEEE, 15, 18
- keyboard, 17
- line-in, 18
- line-out, 18
- mouse, 17
- network adapter, 17
- power, 16
- sound, 18
- USB, 15, 18

contacting Dell, 181

cooling, 49

copying BDs, 40

- general information, 38
- how to, 39

copying CDs

- helpful tips, 40
- how to, 39

copying DVDs

- general information, 38
- helpful tips, 40
- how to, 39

cover

- closing, 160

CPU overclocking, 49

D

Dell

- contacting, 179, 181
- support site, 11

Dell Diagnostics, 72

Dell Premier Support website, 9

Device Driver Rollback, 76

diagnostic lights, 66

diagnostics

- beep codes, 69
- Dell, 72
- lights, 66

display. See *monitor*

documentation

- End User License Agreement, 9
- ergonomics, 9
- online, 11
- Product Information Guide, 9
- regulatory, 9

documentation (*continued*)
safety, 9
warranty, 9

drive panel, 113
replacing, 114

drivers
about, 75
identifying, 75
reinstalling, 76

Drivers and Utilities
Media, 76

drives
problems, 53
RAID, 29

dual graphics technology, 49

dual monitors, 23

DVDs
about, 38

E

e-mail
problems, 55

End User License
Agreement, 9

ergonomics information, 9

error messages
beep codes, 69
diagnostic lights, 66
problems, 56
system, 70

F

Factory Image Restore, 80-81

G

graphics
dual graphics, 49

H

hard drive
activity light, 15
problems, 54

hardware
beep codes, 69
conflicts, 83
Dell Diagnostics, 72
drives, RAID configuration, 29

Hardware Troubleshooter, 83

headphone
connector, 15, 18

Help and Support, 11

helpful tips, 40

hibernate mode, 45-47

I

IEEE
connectors, 15, 18

IEEE 1394
problems, 57

installing parts
before you begin, 85
recommended tools, 85
turning off your computer, 85

Internet
problems, 55

IRQ conflicts, 83

K

keyboard
connector, 17
problems, 57

L

labels
Microsoft Windows, 10
Service Tag, 10

lights
diagnostic, 66
front of computer, 66
hard drive activity, 15
link integrity, 17
network, 17
network activity, 17
power, 14

liquid cooling, 49, 128

M

media
operating system, 12
media card reader
using, 41

- memory
 - 4-GB configurations, 91
 - DDR2 overview, 90
 - installation guidelines, 90
 - installing, 92
 - problems, 59
 - removing, 93
 - type supported, 90
- messages
 - error, 56
 - system, 70
- Microsoft Windows label, 10
- modem
 - problems, 55
- monitor
 - blank, 63
 - clone mode, 28
 - connect DVI, 22, 24
 - connect TV, 22
 - connect VGA, 22-24
 - connecting, 22
 - connecting two, 23-24
 - display settings, 28
 - dual monitors, 22
 - extended desktop mode, 28
 - hard to read, 64
 - problems, 63
- mouse
 - connector, 17
 - problems, 60

N

- network
 - connector, 17
 - Network Setup Wizard, 42
 - problems, 60

O

- operating system
 - media, 12, 82
 - reinstalling, 12
 - reinstalling Windows Vista, 78
 - reinstalling Windows XP, 78
- optical drive, 123
 - problems, 54
- overclocking, 49, 172

P

- password
 - clearing, 176
 - jumper, 176
- PC Restore, 80
- performance, 49
- phone numbers, 181
- power
 - button, 14
 - connector, 16
 - hibernate mode, 45-47
 - light, 14
 - options, 45

power (*continued*)

- options, schemes, 46
- problems, 61
 - sleep mode, 47
 - standby mode, 44
- power light, 65
 - conditions, 61
- power options properties, 45
- printer
 - problems, 61
- problems
 - battery, 53
 - beep codes, 69
 - blue screen, 59
 - CD-RW drive, 54
 - computer crashes, 58-59
 - computer stops responding, 58
 - conflicts, 83
 - Dell Diagnostics, 72
 - diagnostic lights, 66
 - drives, 53
 - e-mail, 55
 - error messages, 56
 - general, 58
 - hard drive, 54
 - IEEE 1394, 57
 - Internet, 55
 - keyboard, 57
 - memory, 59
 - modem, 55
 - monitor hard to read, 64
 - monitor is blank, 63
 - mouse, 60

problems (*continued*)

- network, 60
- optical drive, 54
- power, 61
- power light conditions, 61
- printer, 61
- program crashes, 58
- program stops responding, 58
- restore to previous state, 78
- scanner, 62
- screen hard to read, 64
- screen is blank, 63
- software, 58-59
- sound and speakers, 63
- video and monitor, 63
- volume adjusting, 63

- processor
type, 163

Product Information Guide, 9

Q

QuickSet, 51

R

- RAID
configuring, 29
- RAID array, creating, 34
- regulatory information, 9
- reinstalling
Windows Vista, 78
Windows XP, 78

S

- safety instructions, 9
- scanner
problems, 62
- screen. See *monitor*
- Service Tag, 10
- settings
system setup, 168
- sleep mode
about, 47
- software
conflicts, 83
problems, 58-59
- sound
problems, 63
volume, 63
- sound connectors
center subwoofer/LFE, 18
line-in, 18
line-out, 18
- speaker
problems, 63
volume, 63
- specifications
computer information, 163
connectors, 165
controls and lights, 165
drives, 165
environmental, 167
expansion bus, 164
memory, 163
physical, 167

specifications (*continued*)

- power, 166
- processor, 163
- technical, 163
- video, 163-164
- standby mode, 44
- support
contacting Dell, 179, 181
- support website, 11
- system messages, 70
- System Restore, 78
- system setup, 168
entering, 168
options, 169
screens, 168

T

- telephone numbers, 181
- troubleshooting
conflicts, 83
Dell Diagnostics, 72
diagnostic lights, 66
Hardware Troubleshooter, 83
Help and Support, 11
restore to previous state, 78

TV

- connect to computer, 22

U

USB

- booting to devices, 175
- connector, 18
- connectors, 15

V

- video
 - problems, 63
- volume
 - adjusting, 63

W

- warranty information, 9
- Windows Vista
 - Device Driver Rollback, 76
 - Factory Image Restore, 80
 - Help and Support, 11
 - hibernate mode, 47
 - Network Setup Wizard, 42
 - reinstalling, 78
 - sleep mode, 47
 - System Restore, 78
- Windows XP
 - Device Driver Rollback, 76
 - Help and Support, 11
 - hibernate mode, 45
 - Network Setup Wizard, 42
 - PC Restore, 80
 - reinstalling, 78
 - standby mode, 44
 - System Restore, 78
- wizards
 - Network Setup Wizard, 42

